

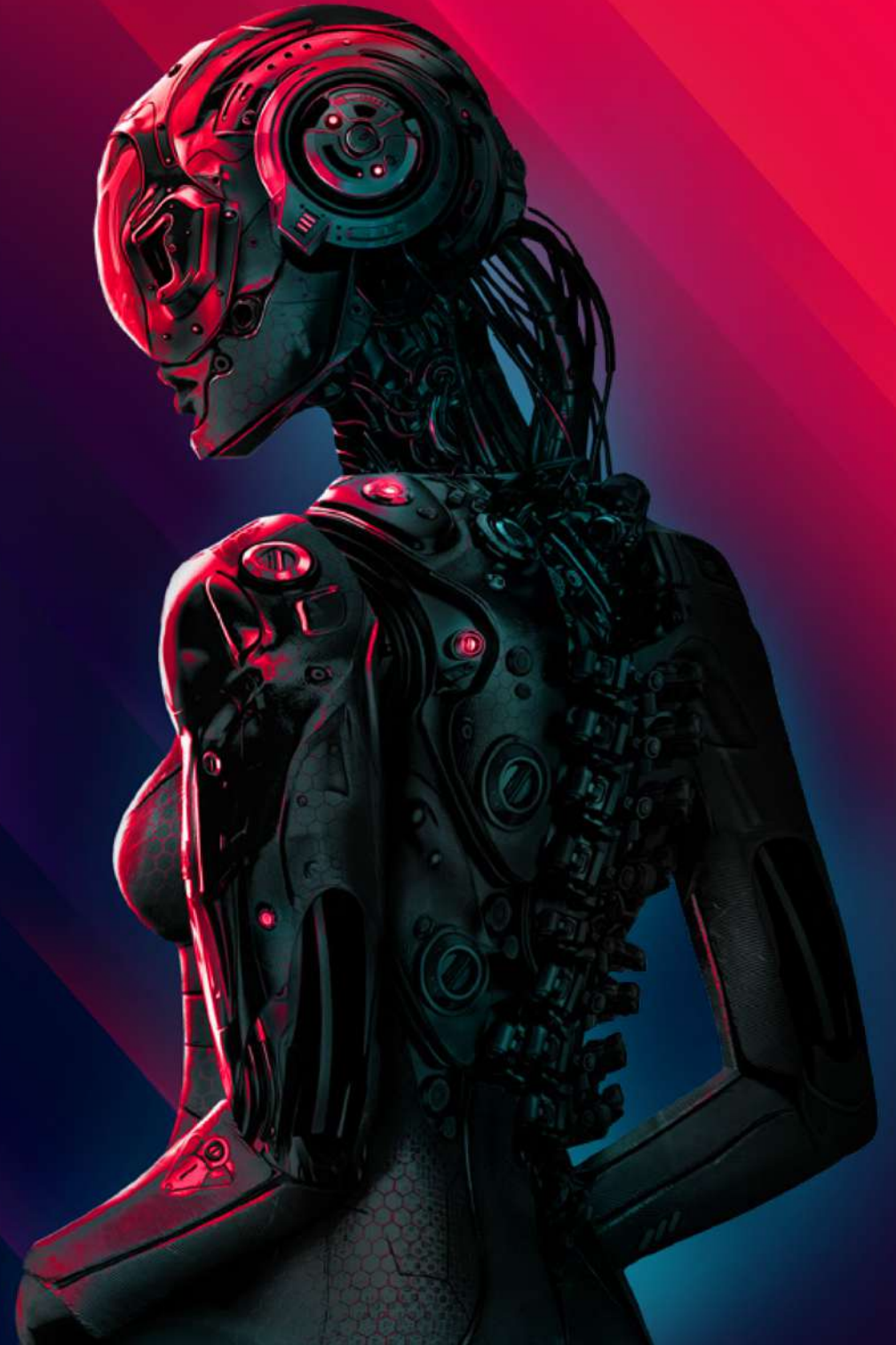

LORGAR

GAMING ACCESSORIES

H 1 / 2 0 2 4





CONTENT

GAMING ACCESSORIES:

MICE	6
KEYBOARDS	29
HEADSETS	40
GAMEPADS	112
CHAIRS	125
WEB-CAMERAS	181
MICROPHONES	206
MOUSE PADS	244



READY TO PLAY

BRAND POSITIONING

LORGAR is a brand of **high functional gaming devices** for advanced gamers, for whom gaming is a lovely and valuable **hobby**.

LORGAR IS YOUR EXCITING
GAMING HOBBY!

TARGET AUDIENCE

Young players with 3+ years of active gaming experience

They value functionality of gaming devices first

Well-versed in gaming devices

Advanced amateur gamers

Gaming is a favorite exciting hobby





LORGAR IS YOUR RIGHT CHOICE!



A team of experienced gamers developed LORGAR devices for advanced players. Our products and software meet all the requirements in terms of functionality and bring even more to the table.



We made sure that our devices have robust design, unique features, and efficient technology inside.



The advanced Lorgar Platform increases product functionality tenfold to help you feel the drive and crush your gaming goals.

PROFESSIONAL SOFTWARE

LORGAR PLATFORM

SOFTWARE USP*s:

- Unique statistics module
- Profile sharing
- Personalized offers to user
- Loyalty program for users
(to be developed before the end of 2024)

- All your devices in one Lorgar Platform
- Plug&Play connection
- Intuitive and user-friendly interface
- Online personal technical support

*RAZER, HyperX and Logitech don't have these features





GAMING ACCESSORIES

MICE





LORGAR



JETTER 357

Gaming Mouse

JETTER 357 GAMING MOUSE

Squeeze the most out of your gaming experience with Jetter 357 – our lightweight and ergonomic gaming mouse. Thirty million clicks durability and our gaming-grade Pixart sensor with up to 8000 DPI will make your sessions seamless.

With 6 programmable buttons, you can create custom combinations while the Key Balance system makes every click count. Jetter 357 enhanced RGB system of backlight and 6 modes of backlight effects let you customize the way your mouse looks to match your gaming rig.

Discover your performance with Lorgar Platform: view mouse speed, distance range, total clicks, and more. On top of that, you'll find two gifts in the bundle: a branded keychain and two fidgeters.

Jetter 357 is everything a gaming mouse must be.



Key balance system



Ergonomic design



Gaming-grade optical sensor



True RGB backlight



100% PTFE mouse feet



ERGONOMIC DESIGN, LIGHTWEIGHT

Ergonomic and lightweight – only 75 grams, this gaming mouse feels comfortable regardless of the hand size and grip.

6 PROGRAMMABLE BUTTONS

With 6 durable (30M clicks) and programmable buttons, you can set your mouse up for different game scenarios, no matter the genre. The KBS feature provides a single level of click resistance wherever you click both buttons.



PTFE FEET

Specially developed feet material provides smooth and precise gliding even with long-term use.



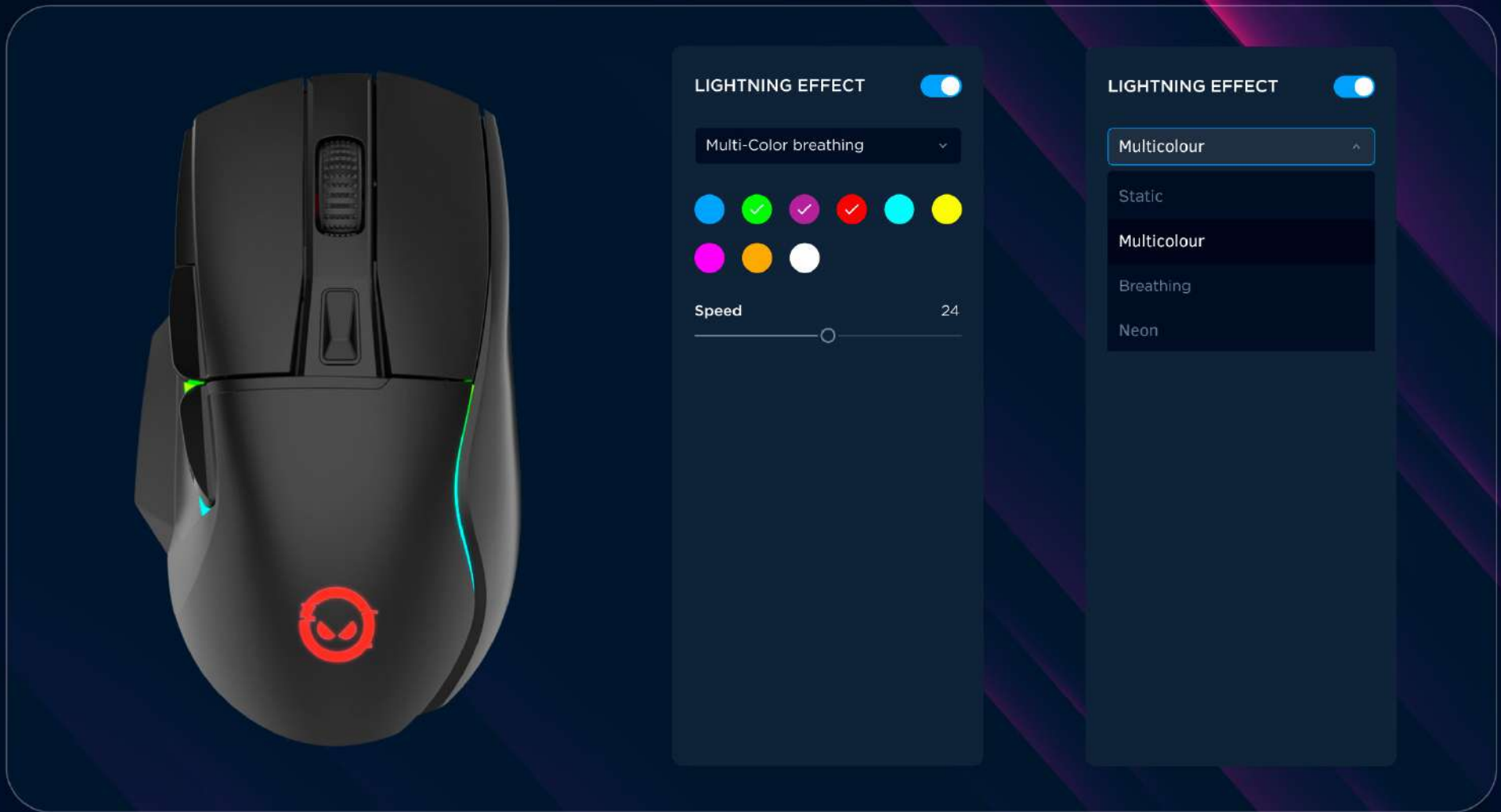

ENHANCED RGB SYSTEM OF BACKLIGHT

Control the backlight using one of the 4 modes or choose a color to match your gaming setup.

GAMING-GRADE PIXART SENSOR

High-performing optical Pixart sensor provides reliable performance even at high DPI parameters. Compatible with all types of gaming surfaces.

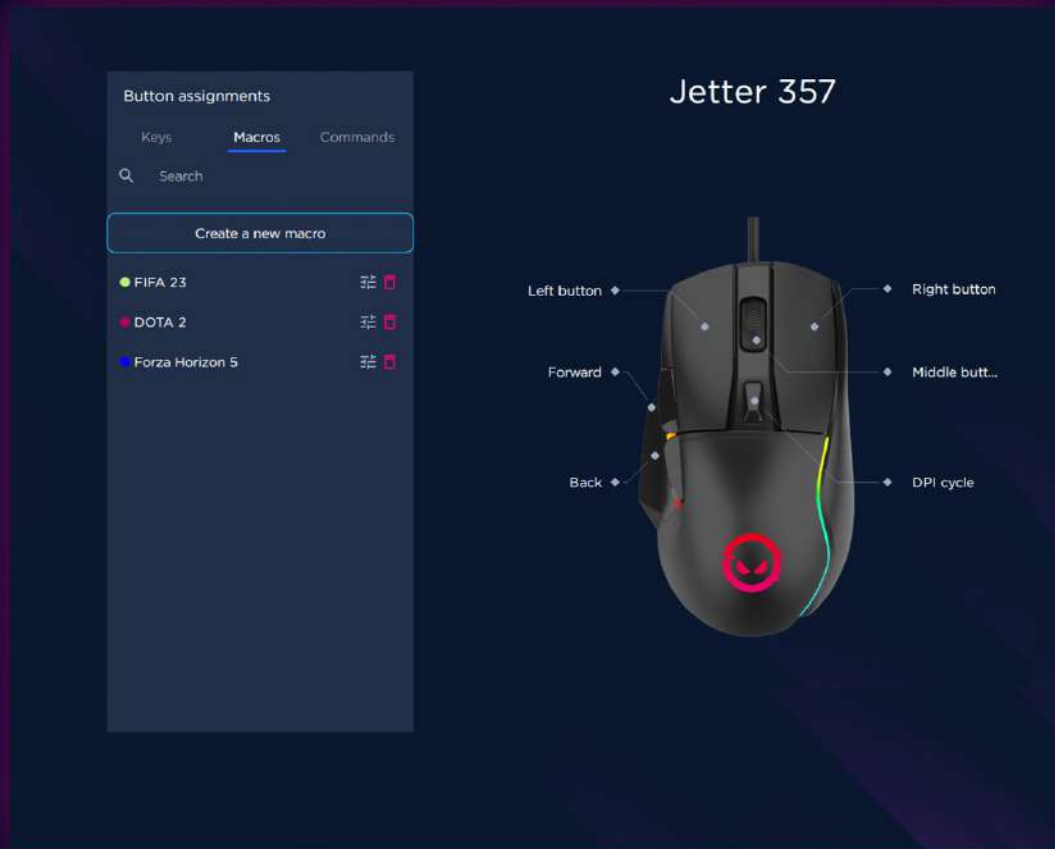

LOGGAR PLATFORM

Our original Loggar Platform lets you access advanced settings and customization, from mouse backlight to macros logging.



DISCOVER YOUR PERFORMANCE

With Lorgar Platform, you can explore personal activity stats. The number of clicks, game speed, mouse range, and even more is available in the original Lorgar Platform module.

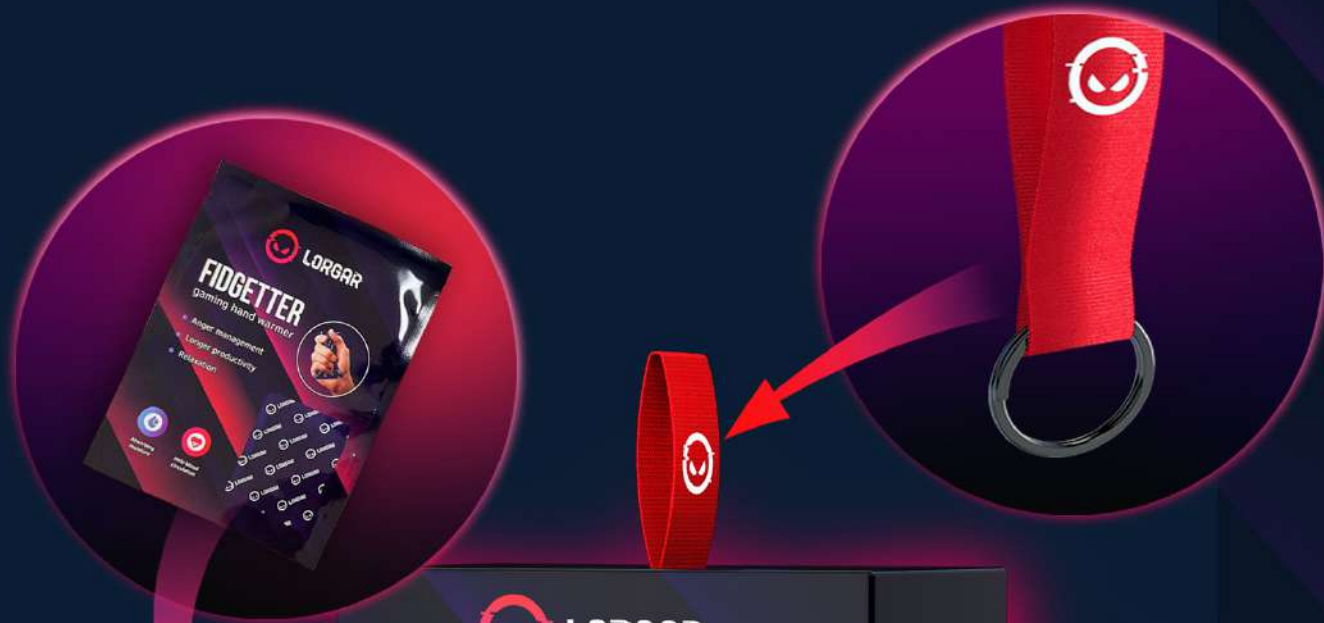

GIFTS

You'll find a unique gift bundle in each mouse set – two fidgeters and a branded keychain attached to the box. Don't forget to take it out before throwing the box away.



STRICTER 579

Gaming Mouse

STRICTER 579 GAMING MOUSE



Looking for a high-precision gaming tool?
Lorgar Stricter 579 could be your mouse of choice.

Ergonomic design, combined with its classic size and weight, minimises your time getting to grips with Stricter 579. The mouse feet are made of 100% PTFE and provide the smoothest glide. The ease of motion is further optimised by the flexible and durable silicone cable.

With its advanced Pixart PMW3336 sensor of 12000 DPI, this sleek and sturdy mouse delivers precision and accuracy like never before. The OLED screen, nine durable programmable buttons with an impressive lifecycle of 50 million clicks for the left and right buttons, two switches with force adjustment, and synchronisable RGB backlight bring personalisation to unmatched levels. All thanks to Lorgar Platform — our proprietary platform to enrich your gaming experience.

Stricter 579 combines comfort, functionality, and performance in one powerful package.



● LRG-GMS579 | black | 5291485010621

FULLY CUSTOMISABLE VIA LORGAR PLATFORM

Our original Lorgar Platform lets you use your new Lorgar device to the max: track performance, make custom game profiles, manage RGB backlight, sync with other Lorgar devices, plus other features.





DISCOVER YOUR PERFORMANCE

With the Lorgar Platform, you can utilise the statistical module to monitor your gaming sessions' activity and compare behaviour across various applications. Discover your average cursor speed, mouse distance traveled, remaining clicks to reach the promised 50 million, and many more.

RGB BACKLIGHT

The RGB backlight is adjustable with Lorgar Platform and can synchronise with other Lorgar products, such as our RGB mouse pad.



9 PROGRAMMABLE BUTTONS

Left and right mouse buttons with an impressive lifecycle of 50 million clicks, scroll button with backlight, resolution increase and resolution decrease buttons, Fn button, fire button, forward button, back button – all these are ready to be binded according to your preferences.

More buttons, more control, more possibilities.





TWO SWITCHES WITH FORCE ADJUSTMENT

Select the required click force, depending on your role in the game: heavier force for clarity of click when sniping or lighter force for swiftness of reaction in close quarters.

BUILT-IN OLED DISPLAY

This handy little screen can show the current settings of your mouse, a Lorgar logo, or basically anything you'd want. Personalise your Stricter 579 and make it stand out.



A close-up, top-down view of a gaming mouse's sensor area. The mouse is dark grey or black with a textured surface. A central sensor is highlighted with a bright red glow and lens flare effects. The background features diagonal purple and blue light streaks.

GAMING-GRADE OPTICAL SENSOR

A 12000 DPI Pixart PMW3336 sensor has a response time of 1 millisecond and provides reliable performance even with 30g accelerations. Compatible with all types of gaming surfaces.



GIFTS INSIDE

There's a gift bundle in each package: additional mouse feet, an eco-friendly cup coaster, two hand warmers, and a keychain. Remember to get all this out before throwing the box away!

TECHNICAL FEATURES

- Sensor: PiXart PMW3336
- DPI, max: 12 000
- Polling rate: 125/250/500/1000Hz
- Scanning frequency: 8000 FPS
- Acceleration, max: 30 g
- 9 programmable buttons with KBS
- The switches lifecycle: 50 mln clicks
- Two switches: 40-45 g
- 4 modes of backlight effects
- Enhanced RGB system of backlight
- Full customisation via Lorgar Platform
- Built-in display
- 100% PTFE feet
- 1.8M USB silicone cable with ferrite ring
- System support: Windows 10/8/7



GAMING MICE PORTFOLIO



JETTER 357



STRICTER 579

	Sensor characteristics	
Sensor	PiXart 4090	PiXart 3336
DPI	200-8000	400-12 000
Polling rate	125-1000 Hz	125-1000 Hz
	Design	
Shape	Ergonomic, right-handed	Ergonomic, right-handed
Number of buttons	7	9
Switches life cycle	30 mln	50 mln
Switches force adjustment	no	yes
RGB zone	3	2
Built-in display	no	yes
Weight, g	75	127
L×H×W, mm	125×82×41	131×72×41
Cable (length, material)	1.8m, USB rubber	1.8m, USB soft silicone
Box content	Mouse, carrying bag, keychain, two hand warmers	Mouse, carrying bag, keychain, two hand warmers, additional mouse feet, cup coaster
	Lorgar Platform	
Backlight customisation	yes	yes
Gaming profiles	yes	yes
Sensor settings	yes	yes
Keys remapping	yes	yes
Macros recording	yes	yes
Personal statistics	yes	yes
	Compliance with gaming genres	
FPS, Action	★ ★ ★ ★ ★	★ ★ ★ ★ ★
MMO/MOBA	★ ★ ★ ★ ★	★ ★ ★ ★ ★
Strategy	★ ★ ★ ★ ★	★ ★ ★ ★ ★
RPG/Casual	★ ★ ★ ★ ★	★ ★ ★ ★ ★



GAMING ACCESSORIES

KEYBOARDS





LORGAR

AZAR 514

Gaming keyboard





AZAR 514 GAMING KEYBOARD



Have you ever wondered what type of keyboard would fit you best?

The Azar 514 is here to eliminate the agony of choice. Thanks to its removable magnetic top cover, this unique mechanical keyboard can shapeshift from classic to skeleton body and is built on a durable aluminium base. The Lorgar linear Dream Switches are smooth and silent, featuring a 2mm actuation point and 40 grams of perfectly balanced actuation force. Combined with the ability to withstand 50 million cycles, these 104 keys will be yours forever. All that goodness is illuminated with an RGB backlight, fully customisable with our Lorgar Platform.

The Azar 514 also features quality-of-life design choices: adjustable rubberised feet, removable Type C spring silicone cable that can stretch up to 3.4m, and a cable management system to keep your workspace organised. This keyboard comes in a monochrome or black colour scheme. With any colour you choose, you'll find some pleasant extras in the package. Pick one today because the Lorgar Azar 514 is finger-clicking good!

3-WAY
CABLE
MANAGEMENT



2-IN-1 BODY
Skeleton / Classic



LORGAR LINEAR DREAM SWITCHES

Smooth & silent Lifespan:
50 million clicks Operation
force: 40 g-force Actuation
point: 2 mm



SPRING CABLE

Detachable cable USB
Type C (to keyboard) USB
Type A (to PC) Adjustable
length: 1.8 - 3.4 m

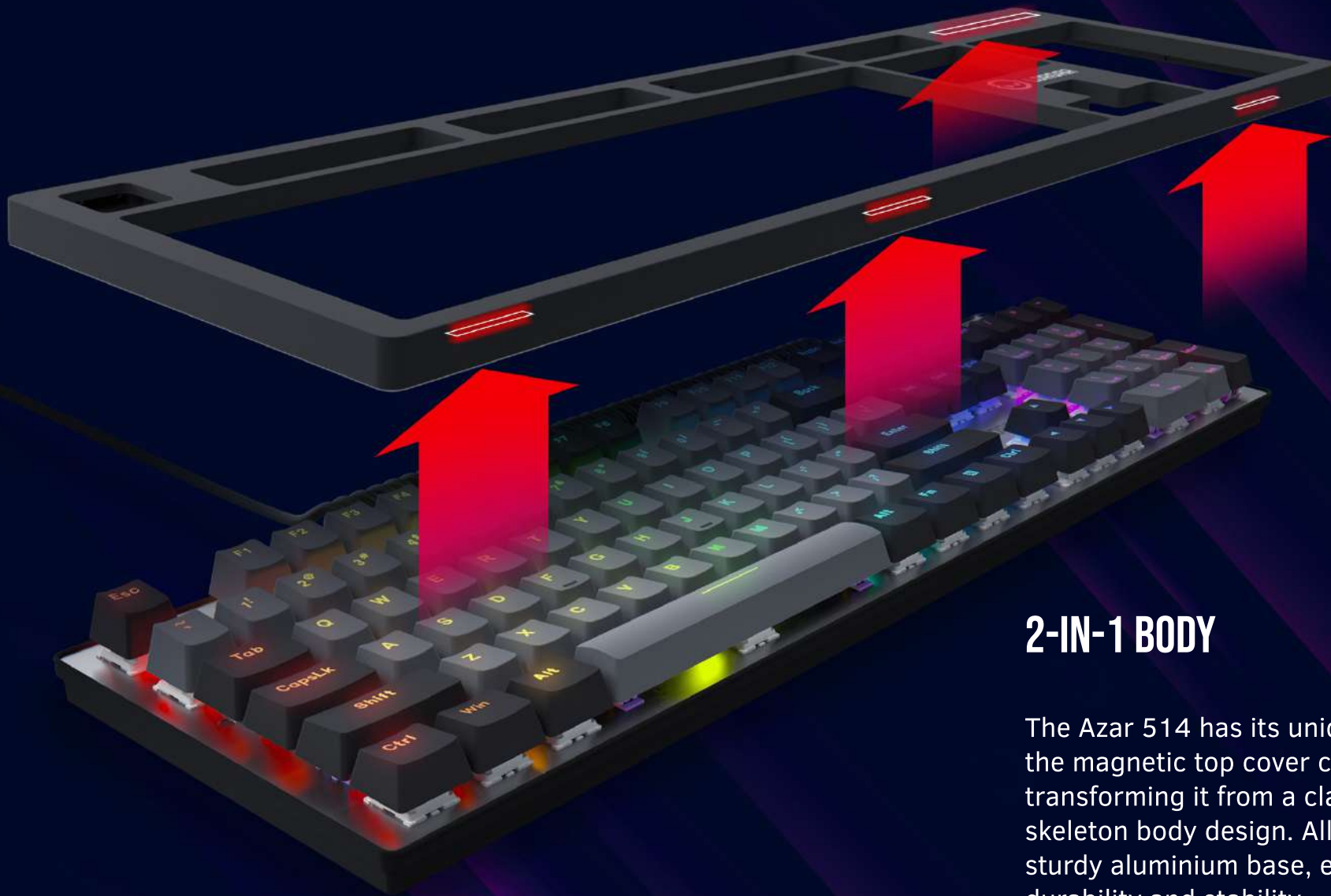

2-IN-1 BODY

The Azar 514 has its unique feature: the magnetic top cover can be removed, transforming it from a classic keyboard to a skeleton body design. All that is built on a sturdy aluminium base, ensuring long-lasting durability and stability.



SMOOTH & SILENT LINEAR DREAM SWITCHES

These Dream Switches can withstand 50 million cycles, making them highly dependable. With the balanced actuation force of 40 grams, no accidental input is expected, and the actuation point of 2mm within 4mm of travel distance gives you a reaction advantage in-game.



CUSTOMISABLE RGB BACKLIGHT

This full-size keyboard features RGB backlighting that can be fully customised and synced with other Lorgar devices using the Lorgar Platform.

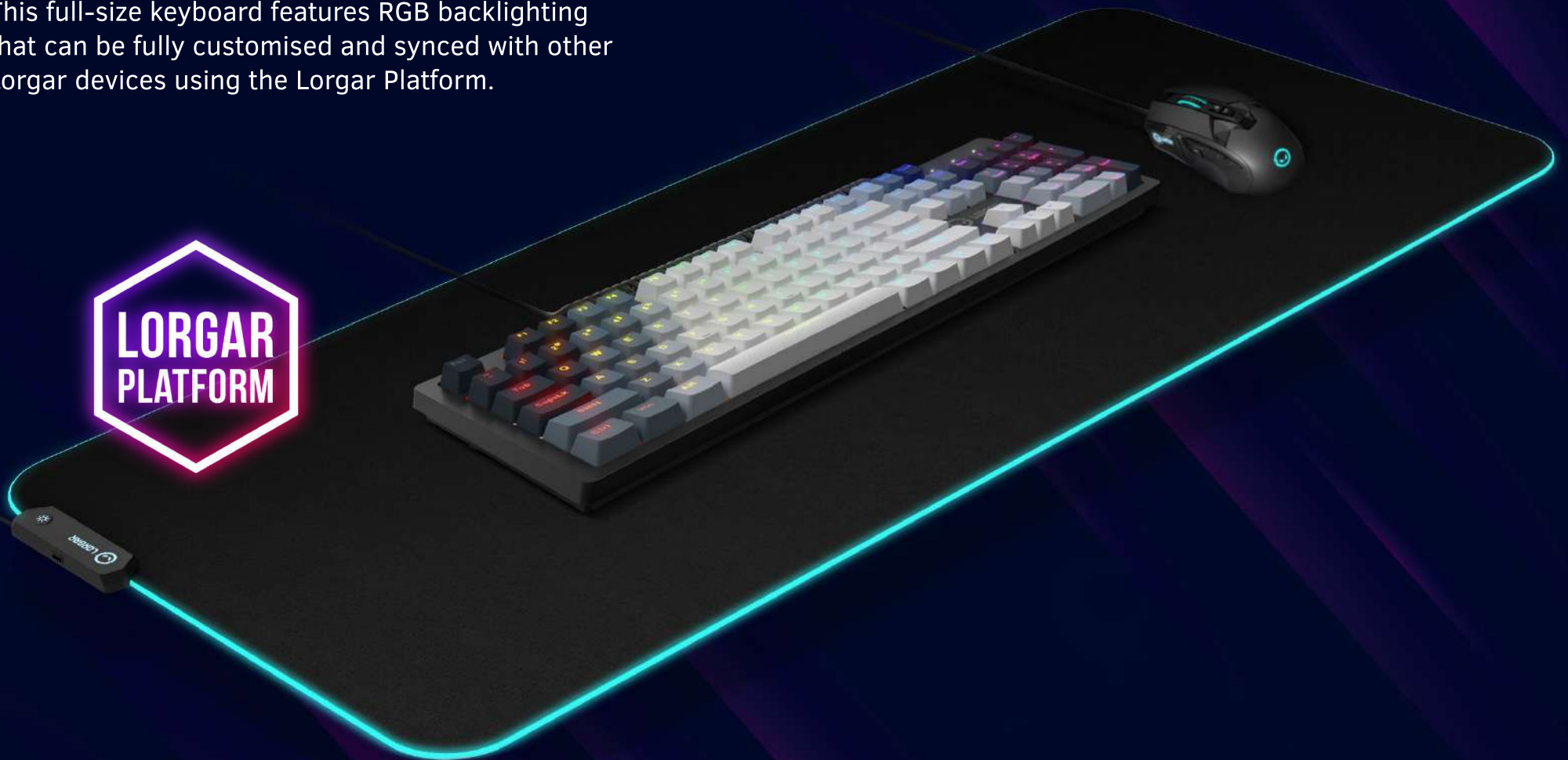

LORGAR PLATFORM

Besides the ability to customise and synchronise your devices' backlight, our software allows you to create gaming profiles, record macros, and remap keys. You can also monitor your gaming performance and statistics for every Lorgar device you own. All of that in one app: Lorgar Platform.





LITTLE IMPORTANT THINGS

The Azar 514 has been designed with user convenience in mind, featuring three-position rubberised feet, removable and flexible spring USB (C) – USB (A) cable of up to 3.4m, and a cable management system to keep your workspace organised.

COLOUR OPTIONS

The Azar 514 comes in two colour options: monochrome and black. The monochrome keyboard has black & white gradient keys, black top cover and white base. The black keyboard goes with black & grey keys, black top cover and gun-metal base.



●	LRG-GK514W-US	white	5291485015503
●	LRG-GK514B-US	black	5291485015480



GIFTS FROM LORGAR

A keychain switch with keycap – you can swap it with any key on your keyboard; a puller, two hand warmers, a cup coaster, and a carrying bag.

TECHNICAL FEATURES

- 2-in-1 body: classic and skeleton
- 104 mechanical keys
- Smooth & silent linear "Dream switches" by Lorgar
- Travel distance: 4 mm
- Actuation point: 2 mm with force 40gf
- 50 million clicks per button
- NKRO support
- 18 modes of backlight
- Customisation with Lorgar Platform
- Detachable spring cable (1.8 - 3.4 m)
- 3-way cable management
- System requirements:
Windows XP/Vista/7/8/8.1/10



GAMING ACCESSORIES

HEADSETS





NOAH 501

Wireless gaming headset





NOAH 501 WIRELESS GAMING HEADSET

Try playing by ear with our brand new Lorgar Noah wireless gaming headset series.

The Lorgar Noah 501 headset is equipped with high-quality 40mm speakers, providing you with a crisp and clear 3D sound. The retractable microphone is easily adjusted to follow the natural shapes of your face. Whenever you are done talking, just retract the mic into the headset. It gets better: your ears enjoy soft and comfortable cushions. Even the longest gaming sessions will bring you only excitement, not soreness. The adjustable size will keep your head comfy and happy – Lorgar headsets think that all skull shapes are beautiful.

Besides, you're playing in style with the red breathing LED backlight.

Noah 501 is true gaming wireless: we kept the latency low to ensure a smooth experience. Pick any platform, whether a mobile phone, PC, or dedicated gaming device – Lorgar Noah 501 is fully compatible with everything. Even more: a high-capacity battery of 1000mA allows you to have fun for up to 58 hours via BT 5.3 connection. If you ever play so hard there's no charge left, just use the 3.5mm jack – the cable is included in the package.



Detachable 3.5 mm
jack included



Compatible with all
gaming and mobile
devices



Up to 58 hours
of play

● LRG-GHS501 | black | 5291485009168

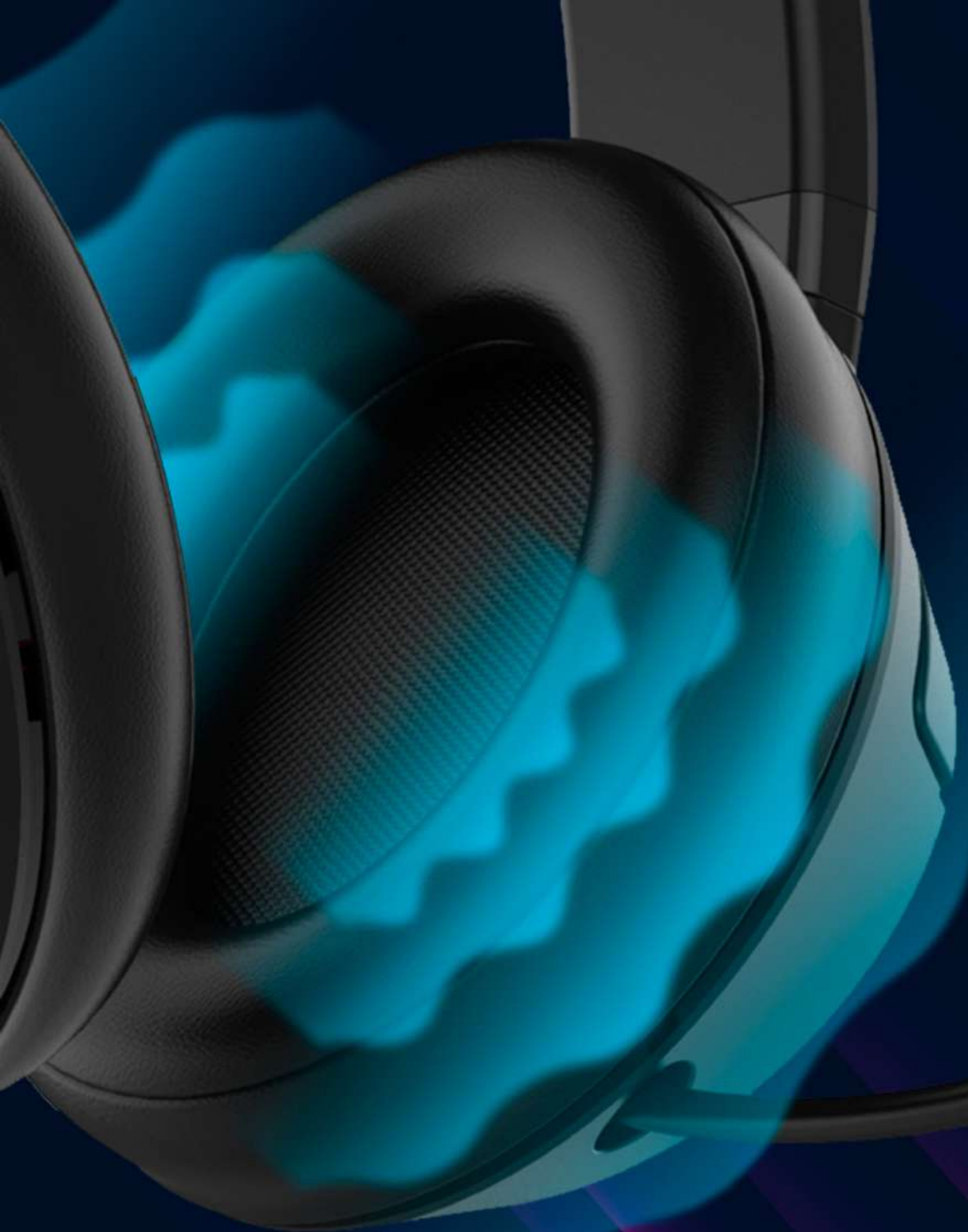

CLEAR SOUND

Crystal-clear 3D surround sound is brought to you by two 40mm speakers with frequency span from 20Hz to 20kHz



RETRACTABLE MICROPHONE

An omnidirectional and easily adjustable microphone follows the shape of your face for optimal performance. AI noise cancelling ensures the clarity of your voice. Sleek design allows the mic to be hidden into the headset while not in use, or you can opt for pushing the dedicated mute button.

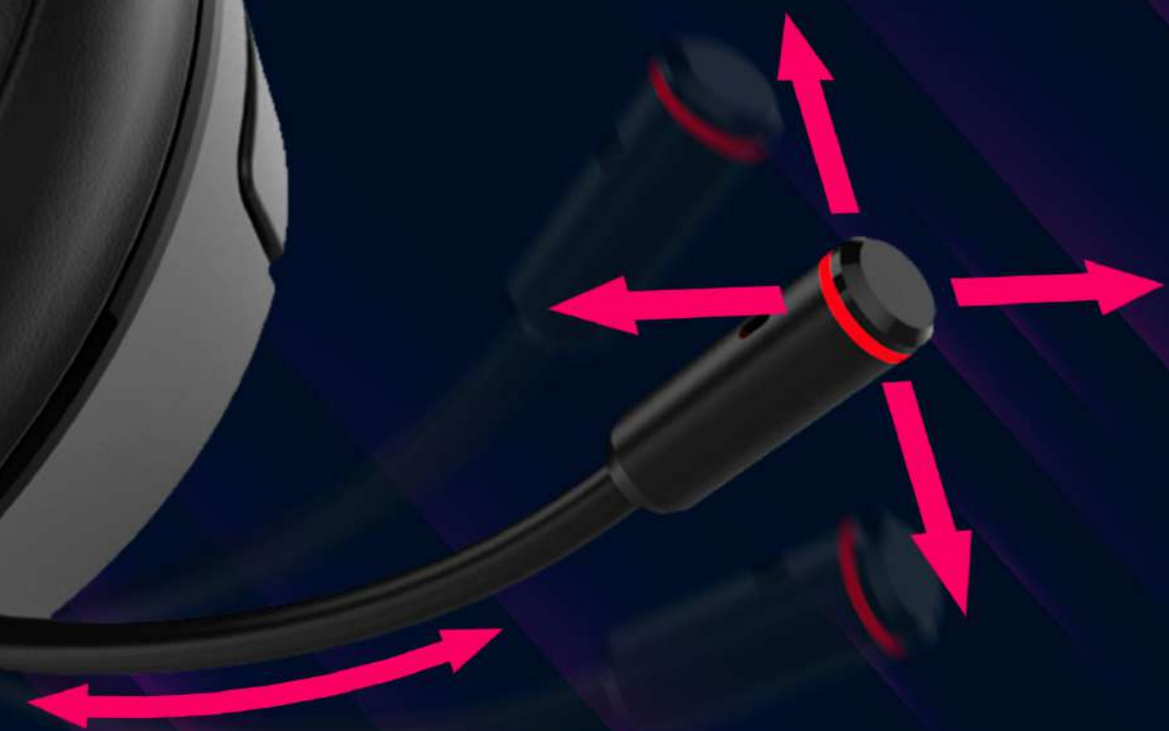



IT'S COMFORTABLE

The PU leather cushions provide top-notch comfort for your skin, and a small weight of just 260 grams keeps your neck happy even after the longest gaming sessions.

ADJUSTABLE SIZE

All shapes and sizes are beautiful, so Lorgar Noah headsets are designed to be adjustable and follow your head's natural silhouette.



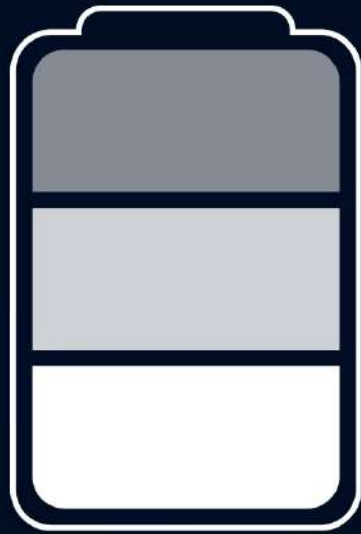

1000 mAh



up to 58h playing time

HIGH CAPACITY BATTERY

A high-capacity 1000mAh built-in battery ensures seamless gaming up to 58 hours when connected via BT 5.3.



FOLDABLE

Fold your Noah 501 while not in use to ensure its safe and convenient packing in your backpack.





LIGHTWEIGHT

Weighing in at only 260 grams, Noah 501 is lightweight and comfortable enough to play all day.

TRUE GAMING WIRELESS

Play your favourite games even in wireless mode thanks to the low latency and instant sound delivery.





COMPATIBILITY

Lorgar Noah series is compatible with all gaming devices, whether it is a PC, mobile or console.



KEYCHAIN INSIDE

Don't forget to get your keychain from Lorgar before you dispose of the packaging!



TECHNICAL FEATURES



Chipset: JL7006



Audio signal to noise ratio: $\geq 90\text{dB}$



BT version: V 5.3



Charging voltage: DC 5V



BT distance: 10m



Working voltage: 3.3-4.2V



Support BT Protocol: A2DP, HFP, HSP, AVRCP



Battery: 3.7 V 1000mA



Speaker type:
Full frequency Horn 40mm 32 Ω



Type C connection



Frequency response: 20Hz-20KHz



NOAH 701

Wireless gaming headset





NOAH 701

WIRELESS GAMING HEADSET

Try playing by ear with our brand new Lorgar Noah wireless gaming headset series.

The Lorgar Noah 701 headset comes with high-quality 40mm speakers that deliver accurate sound. You can adjust the retractable microphone to fit your face's natural contours. Just hide the mic back into the headset when you're through speaking. It just gets better from there as your ears relax in comfortable cushions. Now, even the longest gaming sessions won't make you sore; they'll excite you. The adjustable size will fit any head shape – we took good care of it. And the violet breathing LED backlight looks unique.

To give you a seamless experience, we kept the latency as low as possible in Noah 701. Pick any platform, whether a smartphone, PC, or a dedicated gaming device – this headset will work flawlessly on it. Additionally, a high-capacity battery of 1000mA enables up to 40 hours of enjoyment when connected via a 2.4GHz USB dongle or even longer with BT 5.1. Use the 3.5mm jack instead if you ever play so hard that there is no charge left; the cable is provided in the packaging.



Dongle 2.4 GHz



Low latency <40 ms



Compatible with all gaming and mobile devices

● LRG-GHS701 | black | 5291485009151

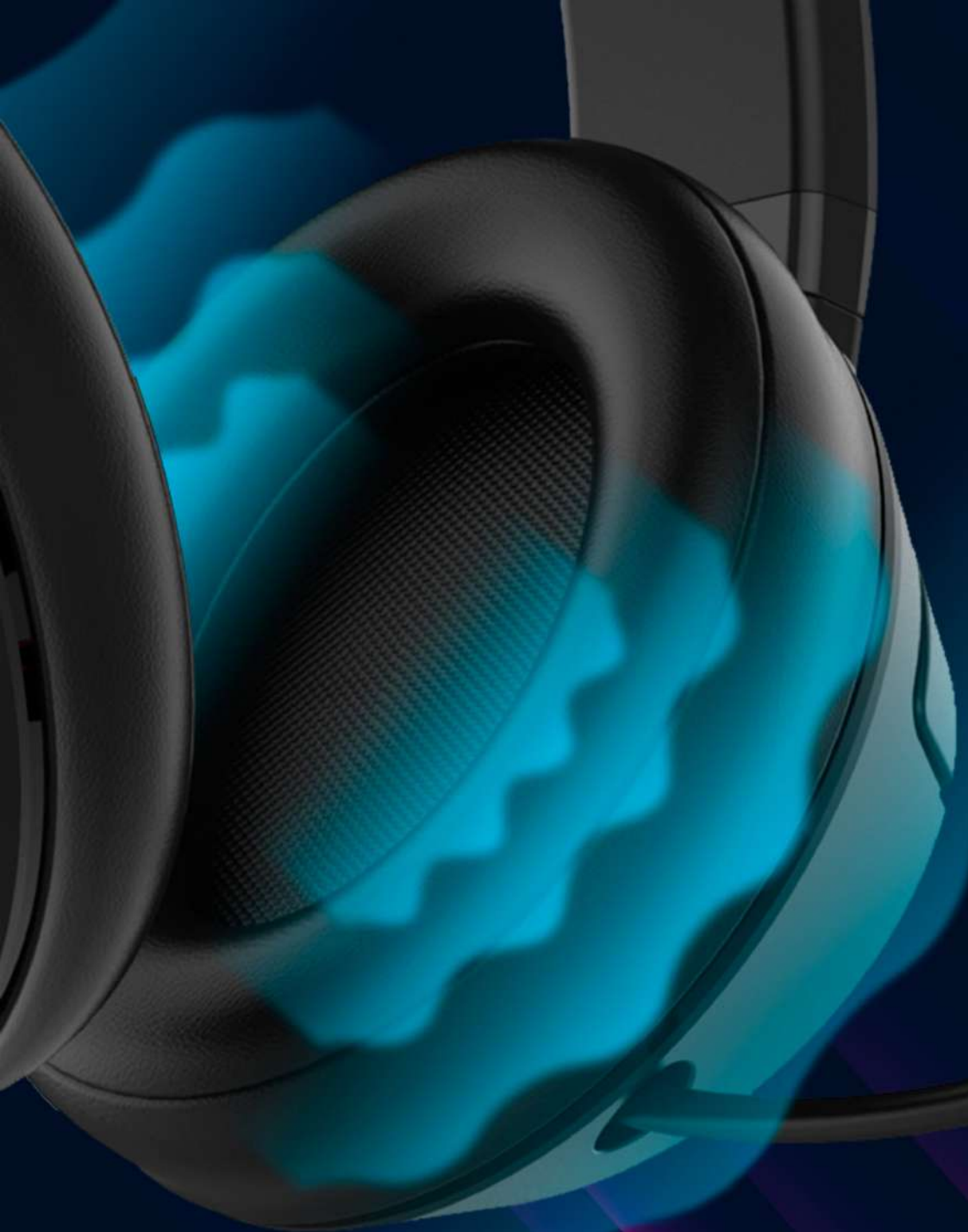

CLEAR SOUND

Crystal-clear sound is brought to you by two 40mm speakers with frequency span from 20Hz to 20kHz



RETRACTABLE MICROPHONE

An omnidirectional and easily adjustable microphone follows the shape of your face for optimal performance. AI noise cancelling ensures the clarity of your voice. Sleek design allows the mic to be hidden into the headset while not in use, or you can opt for pushing the dedicated mute button.





IT'S COMFORTABLE

The PU leather cushions provide top-notch comfort for your skin, and a small weight of just 260 grams keeps your neck happy even after the longest gaming sessions.

ADJUSTABLE SIZE

All shapes and sizes are beautiful, so Lorgar Noah headsets are designed to be adjustable and follow your head's natural silhouette.



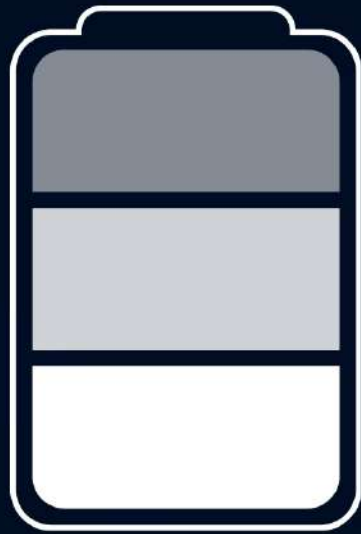

1000 mAh



up to 40h playing time

HIGH CAPACITY BATTERY

A high-capacity 1000mA built-in battery ensures seamless gaming up to 40 hours when connected with a 2.4GHz USB dongle or even more via BT 5.1.



FOLDABLE

Fold your Noah 701 while not in use to ensure its safe and convenient packing in your backpack.





LIGHTWEIGHT

Weighing in at only 260 grams, Noah 701 is lightweight and comfortable enough to play all day.



TRUE GAMING WIRELESS

Play your favourite games even in wireless mode thanks to the low latency and instant sound delivery.



WIDE RANGE OF COMPATIBILITY

Lorgar Noah series is compatible with all gaming devices, whether it is a PC, mobile or console.



KEYCHAIN INSIDE

Don't forget to get your keychain from Lorgar before you dispose of the packaging!



TECHNICAL FEATURES



Chipset: Realtek 8763(for headset) +
8753(for Dongle)



Audio signal to noise ratio: $\geq 90\text{dB}$



BT version: V 5.1



Charging voltage: DC 5V



BT distance: 10m



Working voltage: 3.3-4.2V



Support BT Protocol: A2DP, HFP, HSP, AVRCP



Battery: 3.7 V 1000mA



Speaker type:
Full frequency Horn 40mm 32 Ω



Type C connection



Frequency response: 20Hz-20KHz



KAYA 360

USB gaming headset





KAYA 360 USB GAMING HEADSET

Introducing the Lorgar Kaya 360 USB gaming headset - the ultimate accessory for gamers who value both style and performance. With its sleek design, this headset will turn heads while you dominate the competition. The gunmetal gray colour of the Kaya 360 is just the beginning of its impressive features. Made of durable plastic with a metal-reinforced headband, this headset is built to last. The earcups rotate for comfort and easy storage, while the fabric ear pads provide a comfortable fit during long gaming sessions.

Immerse yourself in your favourite games like never before with crystal-clear sound that puts you right in the middle of the action. Keep in mind there are 40mm speakers with a frequency range of 20–20,000Hz – the audio experience is a symphony of software and hardware with this headset.

The noise-canceling microphone allows you to communicate with your teammates – and you always know if you're live thanks to the built-in LED light. Whenever you don't need to talk, retract it back into the earcup for a clean look. Plus, there's a designated mute button and a volume wheel, so you can control your audio without missing a beat. By the way, Kaya 360 is plug-and-play: connect it via USB-A, and it's ready to roll. Best of all, this Lorgar headset is focused on functionality, and you don't have to pay for bells and whistles.

Upgrade your gaming experience with the Lorgar Kaya 360 today!



Retractable
microphone



Compatible with
Mac OS, Windows, Xbox
and PlayStation

● LRG-GHS360 | black | 5291485010010



BUILD & DESIGN

Kaya 360 is sure to impress. The headset features a gunmetal colour scheme with a glossy Lorgar logo on the side. Kaya is lightweight, weighing only 312 grams, making it easy to wear for extended periods without any discomfort. The adjustable headband ensures a secure fit for any head size.

EARCUPS AND PADS

The rotating earcups offer maximum convenience during long gaming sessions. The fabric ear pads will not irritate your ears even after hours of use. The earcups can also be rotated to store the headset easily.





CLEAR SOUND

The Kaya 360 delivers crystal-clear audio for an immersive gaming experience.

The sound quality is exceptional, allowing gamers to hear every detail in their games, from footsteps to explosions. Be right in the middle of the action!

RETRACTABLE MICROPHONE

A retractable noise-canceling microphone offers clear communication with your teammates, and a built-in LED light will serve as a clear indication you are being heard. The microphone can be easily retracted back into the headset body when not in use, giving the headset a sleek look.



AUDIO CONTROL

A volume control wheel and an instant mute button allow gamers to control their audio without skipping a beat.





WIDE RANGE OF COMPATIBILITY

The USB-A connection with Plug & Play makes it easy to connect Kaya 360 to the most popular gaming platforms. Enjoy hassle-free gaming right out of the box.



KEYCHAIN INSIDE

Don't forget to get your keychain from Lorgar before you dispose of the packaging!



TECHNICAL FEATURES

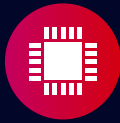

Chipset: CM108B



Speaker type:
Full frequency horn - \varnothing 40mm 32 Ω



Frequency response (speaker):
20 – 20 000 Hz



Frequency response (microphone):
100 – 3000 Hz



Audio signal to noise ratio:
 \geq 90 dB



Charging voltage: DC 5V



Working voltage: 5.0 V



USB-A connection



Cable length: 2 m



NOAH 101

Gaming headset



NOAH 101 GAMING HEADSET

Meet Noah 101, another part of Lorgar's best-selling Noah headset family.

This model comes equipped with top-quality 40mm speakers, delivering clear and excellent sound. The omnidirectional microphone can be easily adjusted to fit the contours of your face. The mic is also conveniently retractable whenever you don't need it. You can find a real mechanical mute button and a just as real volume control dial for reliable audio control. With an adjustable size, the Noah 101 is designed to provide comfort for all head shapes. That's not all – this headset also features big, soft PU leather cushions for your ears. Say goodbye to soreness and discomfort during the long matches.

On top of that, the headset is foldable and easy to carry in your backpack. It is compatible with various platforms, including mobile phones, PCs, and gaming devices, and can be easily connected using the included 3.5mm jack cable. Keep those soundwaves flowing and get your new headset today!



Retractable
microphone



Foldable
design



Compatible with
all gaming and
mobile devices



3.5 mm
to 2 x 3.5 mm
adapter



PU
leather



CLEAR SOUND

Experience rich and clear sound with the 40mm speakers, providing a frequency range of 20Hz to 20kHz.

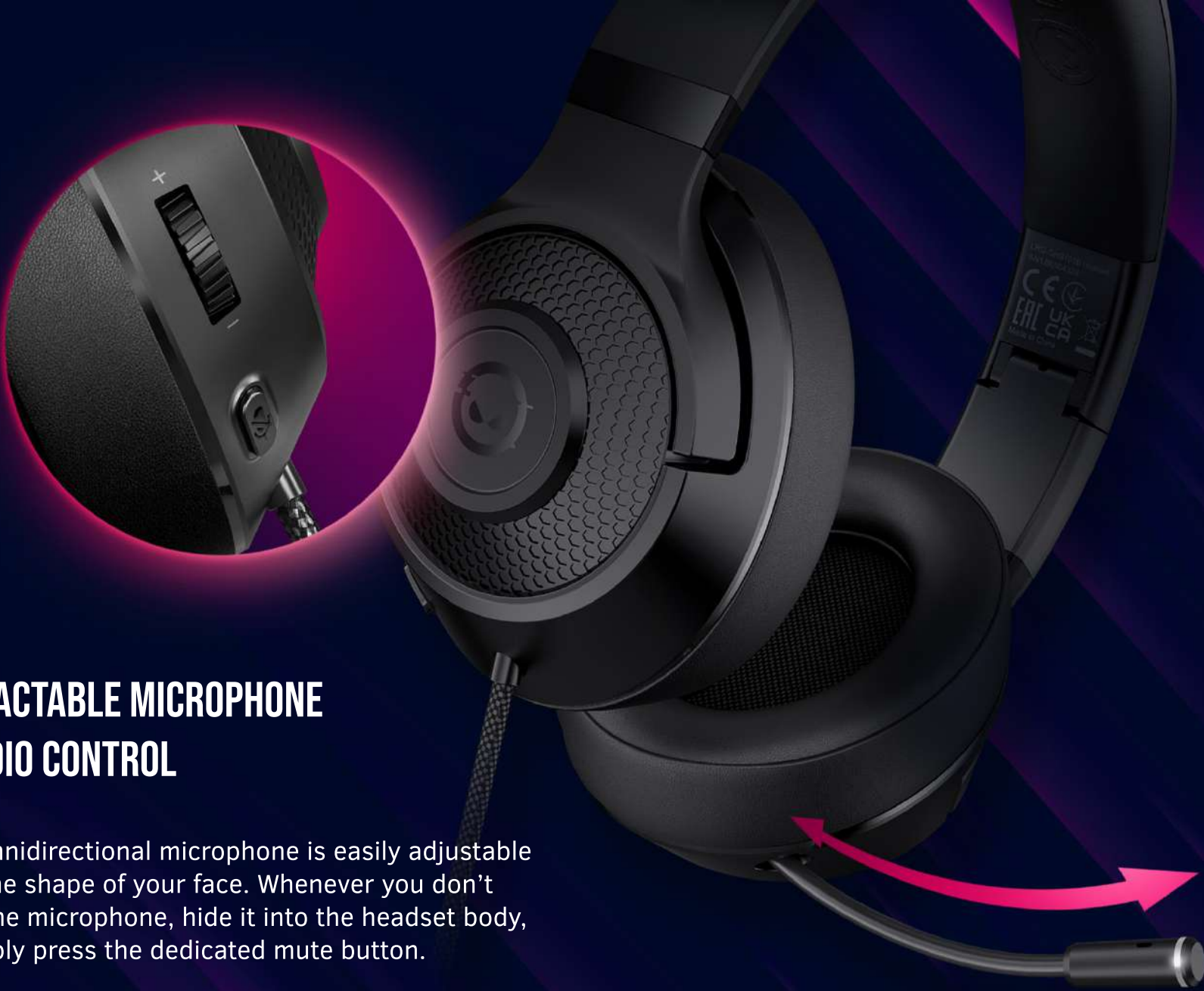

RETRACTABLE MICROPHONE & AUDIO CONTROL

The omnidirectional microphone is easily adjustable to fit the shape of your face. Whenever you don't need the microphone, hide it into the headset body, or simply press the dedicated mute button.

The volume can be adjusted by rotating a mechanical dial.



COMFORTABLE DESIGN

Soft and puffy PU leather cushions and headband will be gentle to your ears, and the total weight of just 245g makes you forget you are wearing the headset.



WIRED CONNECTION

Plug your Noah 101 headset via a 3.5mm jack. Connect it with the included cable of 2 meters and enjoy. No hassle whatsoever. There's a splitter adapter in the package, too!





UNIVERSAL COMPATIBILITY

Noah 101 is fully compatible with all your devices:
PC, mobile, console.

ADJUSTABLE & FOLDABLE

This headset is perfectly adjustable and adapts to the shape & size of your head. Plus, it's easy to fold and carry around in your bag or backpack.



COLOUR OPTIONS

The Noah 101 comes in two colour options:
strict black and minimalistic white.



●	LRG-GHS101W	white	5291485014872
●	LRG-GHS101B	black	5291485014865



KEYCHAIN INSIDE

Remember to get your gift from Lorgar before throwing the packaging away!

TECHNICAL FEATURES



Speaker type:
Full frequency horn - Ø40mm 32Ω



Frequency response
(speaker): 20 – 20 000 Hz



Frequency response
(microphone): 100 – 3000 Hz



Audio signal to noise ratio: ≥ 95 dB



Cable length: 2 m



3.5 mm to 2 × 3.5 mm
adapter included



Foldable design



PU leather



KAYA 460

USB gaming headset





KAYA 460 USB GAMING HEADSET

The Lorgar Kaya 460 is a gaming headset for high-performing players. This headset is sure to catch the eye of fellow gamers with its RGB backlight, and it is just the beginning of its impressive features.

Made with durable plastic and a metal-reinforced headband, this headset is built to endure. The earcups rotate for maximum comfort and convenience, while the fabric ear pads provide a snug fit.

Immerse yourself in the battle with rich sound from the 40mm speakers. The noise-cancelling microphone here allows for clear communication with teammates and features a built-in LED light to indicate when you're speaking. And for times when you don't need to talk, simply retract the microphone into the earcup for a minimalistic look. With a volume wheel and mute button, you can easily control your audio without missing a beat.

Best of all, the Kaya 460 is fully compatible with Lorgar Platform: control and synchronise the backlight, see usage stats, and create individual game profiles. By the way, this headset is plug-and-play: connect it via USB-A and start gaming right away.

Don't settle for less - upgrade your gaming experience with the Kaya 460 today!



True RGB
backlight



● LRG-GHS460 | black | 5291485015336



BUILD & DESIGN

The Kaya 460 really stands out: the RGB backlight shines, and you control it. The headband is reinforced by metal parts and is fully adjustable. The headset is also friendly to your neck, weighing only 329 grams.



EARCUPS AND PADS

The earcups are rotating, ensuring maximum comfort while in use and convenience for storage. The silky-smooth fabric of ear pads is nice to your skin.



RICH SOUND

Thanks to the high-quality 40mm speakers, the sound is so rich and beefy, that it feels almost real. Just give it a try, and you won't look back.



RETRACTABLE MICROPHONE

The noise-cancelling microphone is retractable and offers a perfect readout of your speech. It will take your communication and teamwork to the next level. When not in use, it can be hidden in the earcup.





AUDIO CONTROL

Control the volume with a real dial, and mute your headset with a real button. Some things feel better when they're tangible.



LORGAR PLATFORM SUPPORT

This headset supports Lorgar Platform, so you can see the usage stats, control the RGB backlight or sync it with other Lorgar devices, and create game profiles. Use that to elevate your game!





CONNECTION

Plug & Play functionality ensures you'll get a seamless experience. Connect the Kaya 460 to the most popular gaming platforms via USB-A and enjoy!



KEYCHAIN INSIDE

Don't forget to get your keychain from Lorgar before you dispose of the packaging!



TECHNICAL FEATURES

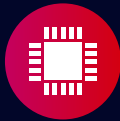

Chipset: CM108B



Customisation
with Lorgar Platform



Speaker type:
Full frequency horn - \varnothing 40mm 32 Ω



Charging voltage: DC 5V



Frequency response (speaker):
20 – 20 000 Hz



Working voltage: 5.0 V



Audio signal to noise ratio:
 \geq 90 dB



USB-A connection



True RGB backlight



Cable length: 2 m



NOAH 500

Wireless gaming headset





NOAH 500 WIRELESS GAMING HEADSET

Sometimes, simplicity is the key. When that's the case, the Lorgar Noah 500 headphones are what you need. They've got excellent 40mm speakers that blast out crisp and clear sound. The mic is retractable and can be adjusted to fit your face, and when you're done talking, just stash it away in the headset. On top of that, the headset itself is also foldable for secure carry in a bag or backpack.

The Noah 500 are also comfy, with soft cushions that keep your ears from getting sore, even during marathon gaming sessions. Plus, they're adjustable to fit all head sizes. The Noah series is perfect for gaming, with low latency that makes sure your game runs smoothly on any platform - phone, PC, or console. And with a huge 1000mA battery, you'll get up to 58 hours of Bluetooth connectivity. Just in case, there's an option for wired connection.

Don't miss this tasty offer – get Noah 500 to hear and be heard.



Detachable 3.5 mm
jack included



Compatible with all
gaming and mobile
devices



Up to 58 hours
of play

● LRG-GHS500 | black | 5291485015473



CLEAR SOUND

Clear and juicy sound is provided by high-quality 40mm speakers with a frequency span from 20Hz to 20kHz.

RETRACTABLE MICROPHONE

The Noah 500 microphone is omnidirectional and can be adjusted to fit your face perfectly, ensuring optimal performance. With noise cancelling technology, your voice will come through crystal clear. When not in use, the mic can be hidden in the headset for a sleek look, or you can use the mute button.





COMFORTABLE

With its lightweight design of only 244 grams, your neck will stay comfortable even during extended gaming sessions. The PU leather cushions offer superior comfort for your skin.

ADJUSTABLE SIZE

The Lorgar Noah headsets are crafted to adapt to your head's unique contours, ensuring a comfortable fit for all shapes and sizes. We believe that every individual is beautiful, and our adjustable design reflects this belief.



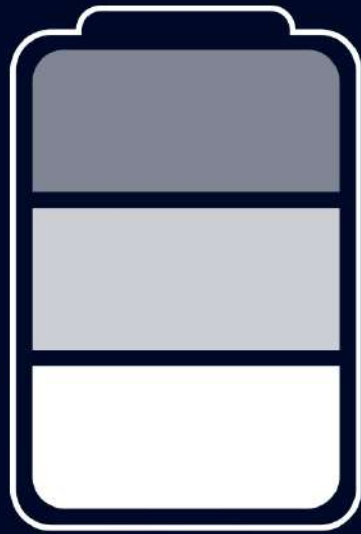

1000 mAh



up to 58h playing time

HIGH CAPACITY BATTERY

With a powerful 1000mAh battery, the Lorgar Noah 500 offers uninterrupted gaming for up to 58 hours when connected through Bluetooth within a 10-meter range.



FOLDABLE

The Noah 500 can be easily folded for safe and convenient carry in your backpack. Take it with you anywhere.

WIRELESS AND WIRED

Thanks to the low latency and instant sound delivery, you can play your favourite games even in wireless mode — this won't affect your gaming performance. If you need a backup plan, we added a cable for wired connection.





COMPATIBILITY

The Lorgar Noah 500 can be used with any gaming device, including PCs, mobiles, and consoles.



KEYCHAIN INSIDE

Don't forget to get your keychain from Lorgar before you dispose of the packaging!



TECHNICAL FEATURES

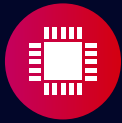

Chipset: JL7006



BT version: 5.3



BT distance: 10m



Support BT Protocol: A2DP,
HFP, HSP, AVRCP



Speaker type:
Full frequency Horn — 40mm 32Ω



Frequency response:
20Hz-20kHz



Audio signal to noise
ratio: $\geq 90\text{dB}$



Charging voltage: DC 5V



Working voltage: 3.3-4.2V



Battery: 3.7 V 1000mA



USB (C) connection

GAMING HEADSETS PORTFOLIO



NOAH 500



KAYA 460



KAYA 360



NOAH 101



NOAH 701



NOAH 501

Connection	wireless	wired	wired	wired	wireless	wireless
BT version	v 5.3	no	no	no	v 5.1	v 5.3
2.4GHz dongle	no	no	no	no	yes	no
Latency	<60 ms	no	no	no	<40 ms	<60 ms
Cable connection	3.5 jack	USB	USB	3.5 jack	3.5 jack	3.5 jack
Software support	no	yes	no	no	no	no
Backlight	no	yes (RGB)	no	no	yes (purple)	yes (red)
Microphone	retractable, omnidirectional	retractable, omnidirectional	retractable, omnidirectional	retractable, omnidirectional	retractable, omnidirectional	retractable, omnidirectional
Noise cancelling microphone	yes	yes	yes	no	yes	yes



GAMING ACCESSORIES



GAMEPADS



TRIX 510

Wireless gamepad





TRIX 510 WIRELESS GAMEPAD

Lorgar TRIX 510 is a multi-platform wireless controller optimized for gaming on Windows, Android, iOS, Nintendo Switch and PS3.

Due to wireless connection with technology BT 5.0 you play up to 10 m from computer/monitor.

Rechargeable lithium-ion battery 600 mAh makes possible to play nonstop up to 8 hours on a single charge, and keep playing while the controller charges.

Placement of all control elements is common for most of gamepads, so you can change your old gamepad for a Trix 510 without any discomfort.

2 vibration motors respond on your actions, help to control playing and enjoy tactile contact.

Embedded motion sensor repeats your body movement for intuitive control while playing in Nintendo Switch.

Led lightings on the button makes comfort playing even in the dark.

Plug and play technology lets you easily connect gamepad to the gaming device without any additional software.

Enjoy the gaming with gamepad Trix 510!



BT adapter
included



Up to 8 hours
of play



Plug & Play



High capacity
battery



5 in 1
multi-platform

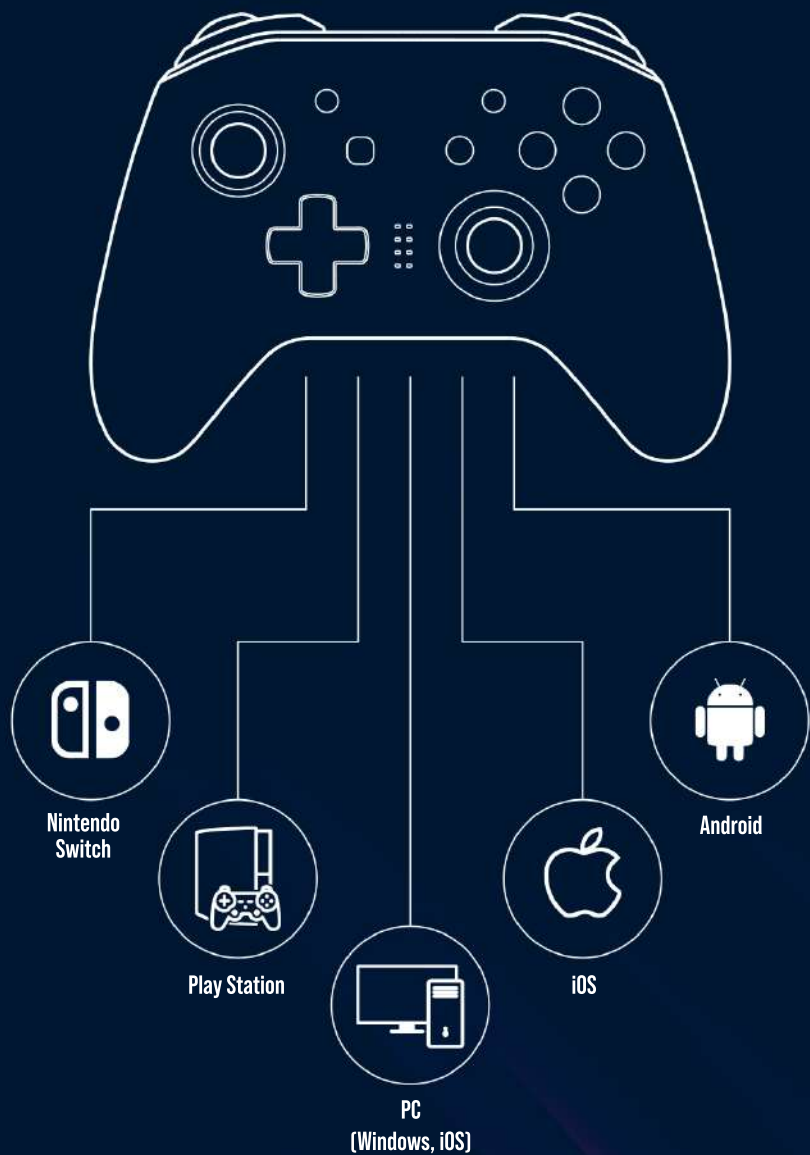

5 IN 1 MULTI-PLATFORM

Multi-platform wireless controller optimized for gaming on Windows, Android, iOS, Nintendo Switch and PS3

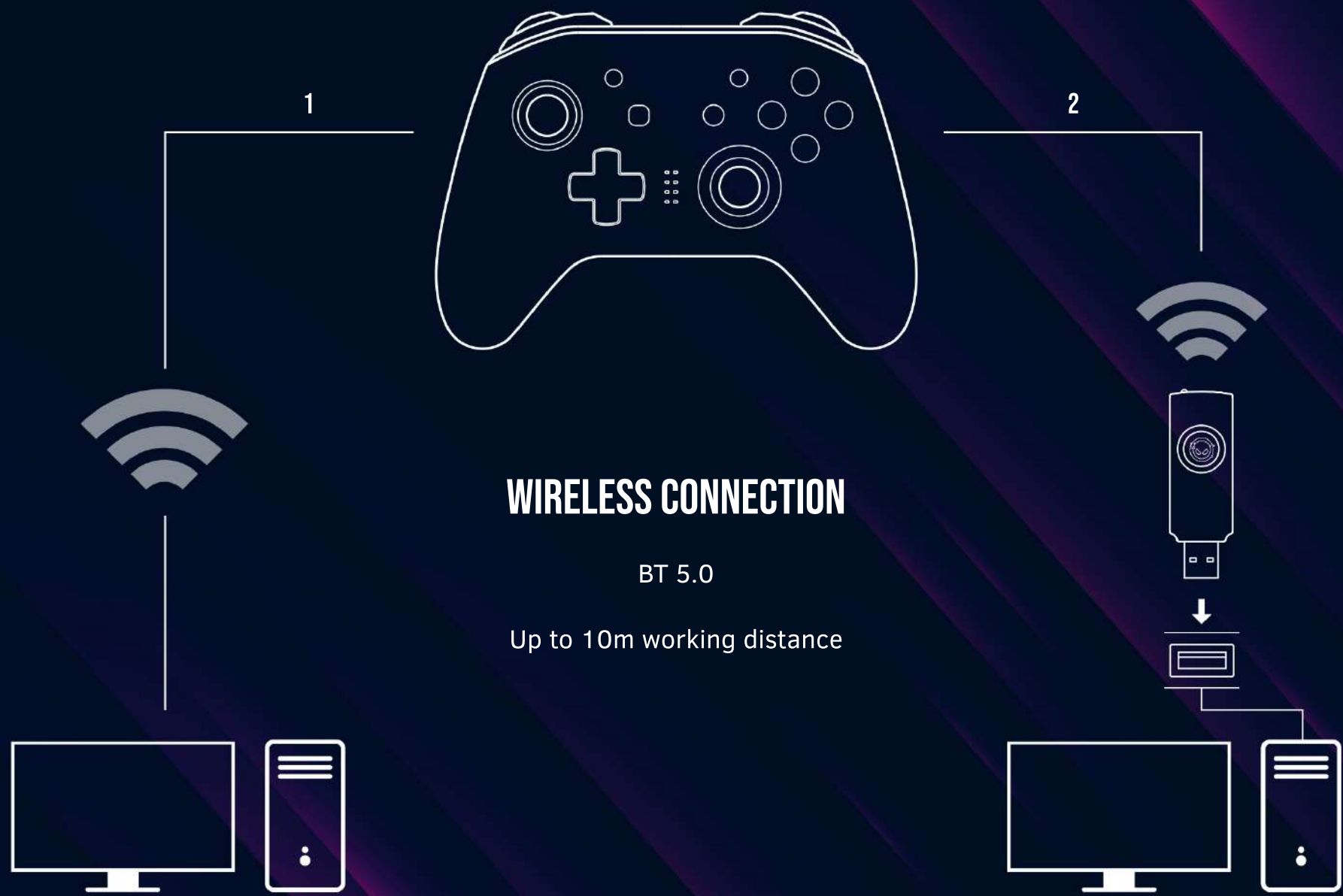

WIRELESS CONNECTION

BT 5.0

Up to 10m working distance

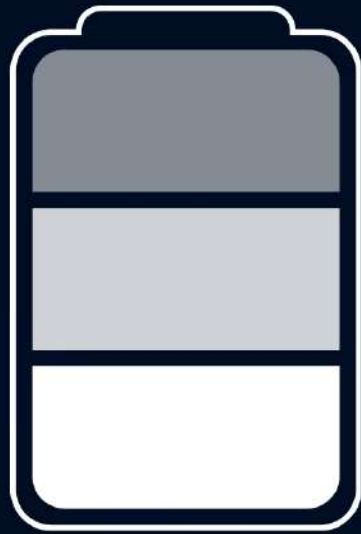

600 mAh



up to 8h playing time

HIGH CAPACITY BATTERY

A rechargeable lithium-ion battery 600 mAh makes possible to play nonstop up to 8 hours on a single charge, and keep playing while the controller charges.

16 BUTTONS

Placement of all control elements is common for most of gamepads, so you can change your old gamepad for a Trix 510 without any discomfort.





VIBRATION FEEDBACK

2 vibration motors respond on your actions, help to control playing and enjoy tactile contact.

MOTION SENSOR

Embedded motion sensor repeats your body movement for intuitive control while playing in Nintendo Switch





START

HOME

LED-BACKLIGHT

Led backlight on the button makes comfort playing even in the dark

PLUG & PLAY

Plug and play technology lets you easily connect gamepad to the gaming device without any additional software





KEYCHAIN INSIDE

Don't forget to get your keychain from Lorgar before you dispose of the packaging!



TECHNICAL FEATURES



Wireless connection BT 5.0



Charge via Type-C port



16 buttons



Compatible with: Nintendo Switch /
Android / Windows / PS3 / iOS



LED buttons backlight



Plug and Play



Vibration feedback



Size: 152 x 102 x 60.5 mm



Motion sensor (Nintendo switch)



Weight: 200 g



High capacity battery : 600 mAh



Warranty 2 years



GAMING ACCESSORIES

CHAIRS





BASE 311

Gaming chair



BASE 311 GAMING CHAIR

You'll surely be able to sit back and relax in this Lorgar Base 311 gaming chair. The dense cold-moulded memory foam seat follows your body shape, and premium-feel eco-leather will withstand years of use. Plus, it's easy to clean and look after! With the neck and lumbar support pillows, you'll effortlessly maintain a healthy posture and reduce fatigue during long gaming sessions. Built around a 1.8mm metal frame, this armchair has an unmatched level of durability. The backrest has impressive recline angles between 90 and 155 degrees, and a five-star aluminium base will ensure your stability while leaning back.

The large 75mm PU casters provide quiet movement – glide around your workplace smoothly and don't worry about damaging the floor. A powerful Class 4 Gas Lift will help you set an optimal height to keep things comfortable. The armrests have four axes of movement: adjustable height, rotation, forward-aft, and inward-outward movement. Hands down, you can rely on them: these armrests are properly reinforced with metal parts. Put as much as 150 kilos on the chair – it's so sturdy it won't notice. For us, proper gaming chair design isn't just about comfort. It's about the care of our customers' well-being.

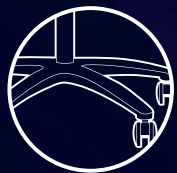

Aluminium
base



4D
armrests



MULTIBLOCK
mechanism



Maximum
loading



HIGH QUALITY ECO-LEATHER AND MEMORY FOAM FEELINGS

The upholstery is made of premium PU eco-leather with heavy-duty stitching. It is pleasant to touch, easy to clean, and hard to tear. The dense cold-moulded memory foam seat is designed to conform to your body shape.

It's difficult to find anything better than that for a gaming chair.





1.8MM

METAL FRAME

We used precision robotic welding to put together the frame. With a metal thickness of 1.8mm, it will serve you for years and years without any deformation. You're probably leaving this chair for your grandkids.

4D



REINFORCED 4D ARMRESTS

The armrests are adjustable to your liking with four degrees of freedom. We guarantee you'll be able to find a comfortable armrest position just for you. Rely on them – the metal base is sturdy enough to withstand the load.

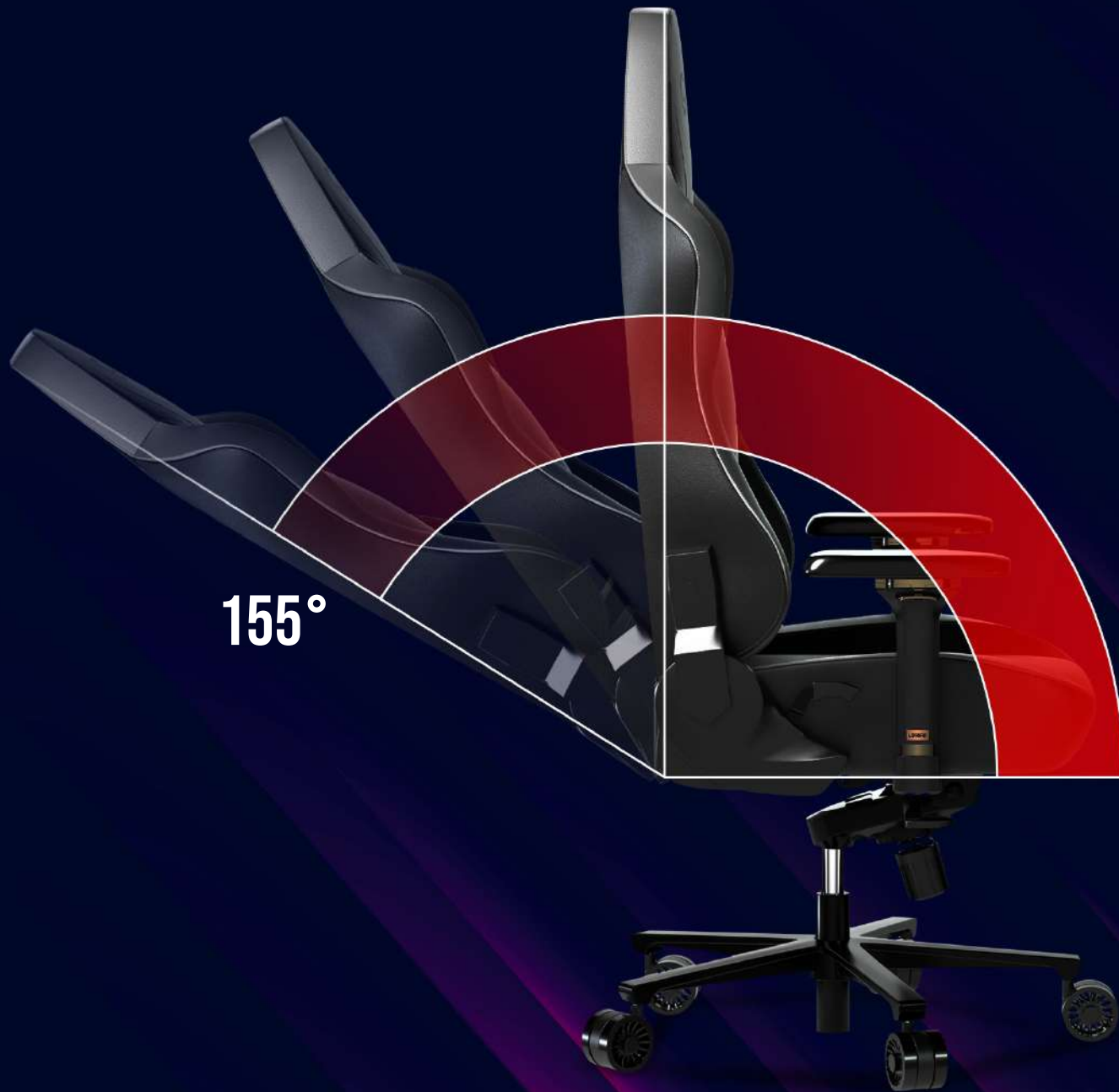

90° – 155°

ADJUSTABLE BACKREST

Whether you are at your peak productivity, casually gaming, or watching some content & chilling – you are provided with a respectable range of backrest adjustments. Well, you can even sleep in this chair if you want to.

MULTIBLOCK MECHANISM

The rocking mechanism allows you to kick back and even lock any inclined angle for your seat between 0° and 13°.

13°





CLASS 4 GAS LIFT

An integral part of any gaming chair, the Class 4 Gas Lift ensures long- lasting operation with a constant load of 150 kilograms.



ALUMINIUM ALLOY FIVE-STAR BASE

A five-star alloy base is dependable. It is sturdy, stays stable, and provides even contact with the surface.

LARGE 75MM PU CASTERS

Sizeable casters made of soft-touch material will roll around easily while also being gentle on the floors.



HEADREST AND LUMBAR SUPPORT PILLOWS

These will support your back, neck, and shoulders during longer gaming sessions. Both pillows are removable. As you might get used to the comfort, there is a temptation to carry them along to your car or office.



COLOUR OPTIONS

The Lorgar Base 311 is offered in a variety of colour choices, so you will definitely find one to fit into your interior.



●	LRG-CHR311BR	red	5291485010249
●	LRG-CHR311BW	white	5291485010256
●	LRG-CHR311BGY	grey	5291485010287
●	LRG-CHR311BBL	blue	5291485010263
●	LRG-CHR311BY	yellow	5291485010270

TECHNICAL FEATURES



High-Quality PU Eco-leather



1.8mm metal frame



4D adjustable armrests



90° – 155° adjustable backrest



Multiblock mechanism



5-star aluminium base



75mm PU casters



Class 4 gas lift



Maximum weight
of chair loading



User's height –
160 cm-195 cm



Dimensions & weight –
1290-1360 x 580 x 510 mm, 25.2 kg



Package list –
chair, headrest support pillow,
lumbar support pillow



ACE 422

Gaming chair



ACE 422 GAMING CHAIR

This Lorgar Ace 422 gaming chair invites you to kick back and relax. Its dense cold-moulded memory foam seat is designed to conform to your body shape. The upholstery is made of a durable anti-stain fabric – it is pleasant to your skin and easy to look after. With the included neck and lumbar support pillows, you can maintain a healthy posture and reduce fatigue during long gaming sessions. The Lorgar Ace 422 is built around a sturdy 1.8mm metal frame, making it incredibly durable. The backrest can be reclined to an impressive angle of up to 155 degrees, and the five-star aluminium base ensures stability when leaning back.

Moving around your workspace is a breeze with the large 75mm PU casters, which provide quiet movement while being safe for your floor. You can adjust the chair's height with the powerful Class 4 Gas Lift to find the perfect comfort level. The armrests are also adjustable, with four axes, including height, rotation, forward-aft, and inward-outward movement. Hands down, you can rely on these reinforced metal armrests to hold up to your use. This model can support up to 150 kilos without showing any strain.

For us, proper gaming chair design isn't just about comfort. It's about the care for our customers' well-being.

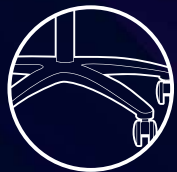

Aluminium
base



4D
armrests



MULTIBLOCK
mechanism



Anti-stain durable
fabric



Maximum
loading



SPECIAL ANTI-STAIN FABRIC AND MEMORY FOAM FEELINGS

For those of you who do not like leather seats, we use high-quality fabric with excellent stretch and durability. The anti-stain treatment provides resistance to liquids and dirt, making cleaning much easier.

The dense cold-moulded memory foam seat follows your body shape. It is difficult to find anything better than that for a gaming chair.



1.8MM

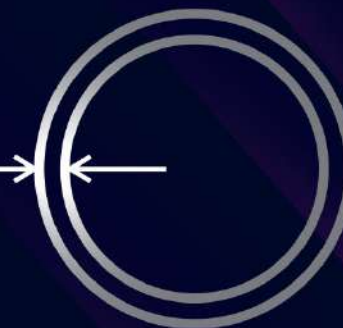

METAL FRAME

We used precision robotic welding to put together the frame. With a metal thickness of 1.8mm, it will serve you for years and years without any deformation. You're probably leaving this chair for your grandkids.

4D

REINFORCED 4D ARMRESTS

The armrests are adjustable to your liking with four degrees of freedom. We guarantee you'll be able to find a comfortable armrest position just for you. You can rely on them – the metal base is sturdy enough to withstand the load.





CLASS 4 GAS LIFT

An integral part of any gaming chair, the Class 4 Gas Lift ensures long- lasting operation with a constant load of 150 kilograms.

MULTIBLOCK MECHANISM

The rocking mechanism allows you to kick back and even lock any inclined angle for your seat between 0° and 13°.

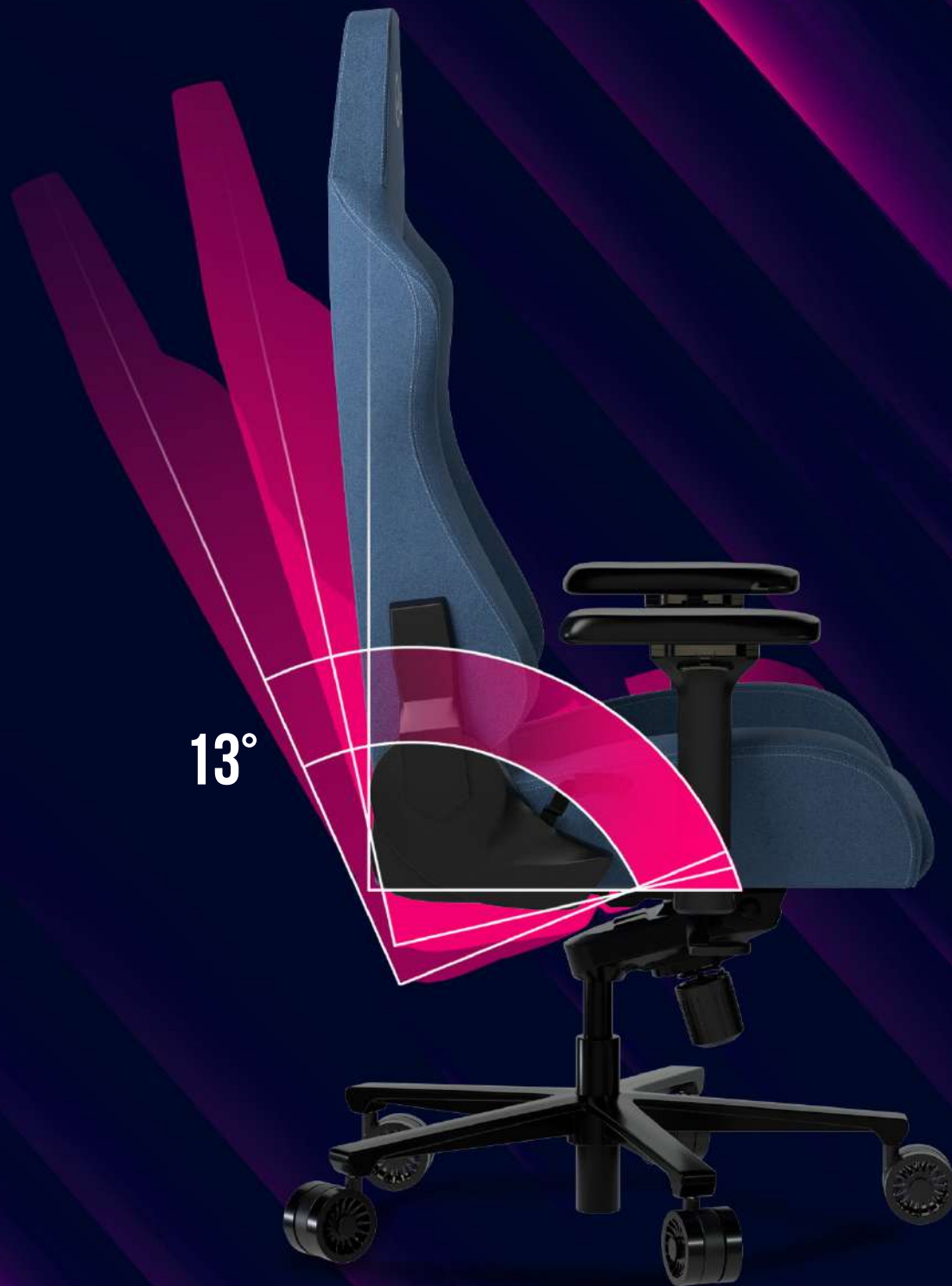

13°

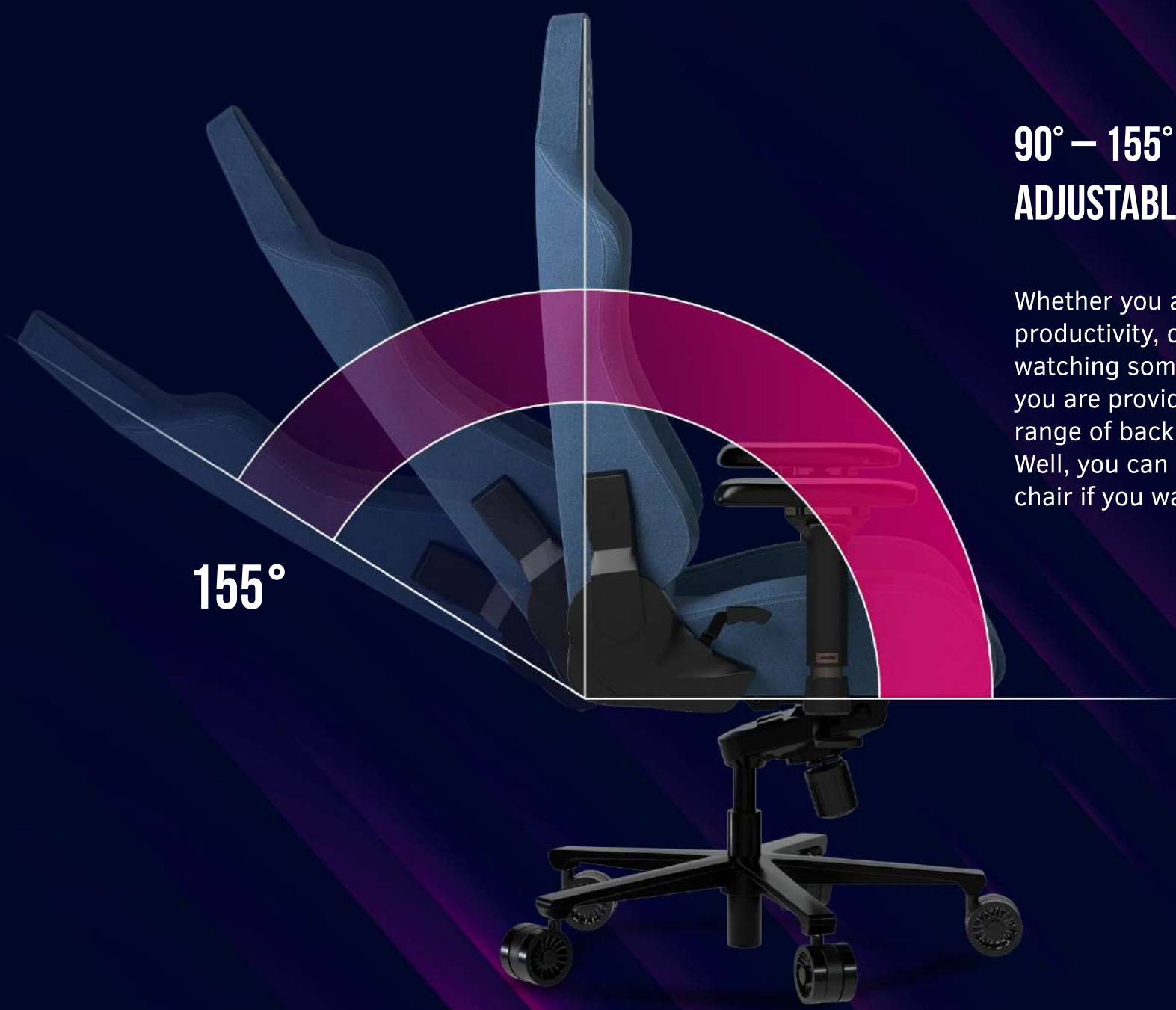

90° – 155° ADJUSTABLE BACKREST

Whether you are at your peak productivity, casually gaming, or watching some content & chilling – you are provided with a respectable range of backrest adjustments. Well, you can even sleep in this chair if you want to.



ALUMINIUM ALLOY FIVE-STAR BASE

A five-star alloy base is dependable. It is sturdy, stays stable, and provides even contact with the surface.

LARGE 75MM PU CASTERS

Sizeable casters made of soft-touch material will roll around easily while also being gentle on the floors.



HEADREST AND LUMBAR SUPPORT PILLOWS

These will support your back, neck, and shoulders during longer gaming sessions. Both pillows are removable. As you might get used to the comfort, there is a temptation to carry them along to your car or office.





COLOUR OPTIONS

The Lorgar Ace 422 is offered in two colour choices – pick one that looks best to you.

●	LRG-CHR422BL		blue		5291485010300
●	LRG-CHR422BR		black		5291485010294

TECHNICAL FEATURES



Special Anti-Stain Fabric



1.8mm metal frame



4D adjustable armrests



90° – 155° adjustable backrest



Multiblock mechanism



5-star aluminium base



75mm PU casters



Class 4 gas lift



Maximum weight
of chair loading



User's height –
160 cm-185 cm



Dimensions & weight –
1250-1320 x 570 x 490 mm, 25 kg



Package list –
chair, headrest support pillow,
lumbar support pillow



EMBRACE 533

Gaming chair



EMBRACE 533 GAMING CHAIR

The Lorgar Embrace 533 gaming chair will offer you a brand-new experience. Its dense cold- moulded memory foam seat conforms to your body shape, and premium-feel eco-leather is soft to the touch. Innovative flexible lumbar support promotes healthy posture and reduces fatigue during long gaming sessions. For your headrest, we added a removable support pillow.

The chair is designed with a sturdy 1.8mm metal frame, ensuring exceptional durability. You can kick the backrest from 90 to 155 degrees, and the five-star aluminium base will ensure proper stability. The Lorgar Embrace 533 is equipped with large 75mm PU casters, engineered to move smoothly and save your floors from any damage. The Class 4 Gas Lift provides precise height adjustment, enabling you to find the perfect comfort level. It can support 150 kilograms daily for years of operation.

The chair's armrests are adjustable in four different ways, including height, rotation, forward- aft, and inward-outward movement, allowing for a truly tailored experience. Even with heavy use, the reinforced metal armrests hold up to daily wear and tear. For us, proper gaming chair design isn't just about comfort. It's about the care for our customers' well-being.

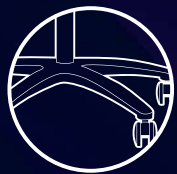

Aluminium
base



4D
armrests



MULTIBLOCK
mechanism



Adjustable
backrest surface



Maximum
loading



HIGH QUALITY ECO-LEATHER AND MEMORY FOAM FEELINGS

The upholstery is made of premium PU eco-leather with heavy-duty stitching. It is pleasant to touch, easy to clean, and hard to tear. The dense cold-moulded memory foam seat is designed to conform to your body shape. It's difficult to find anything better than that for a gaming chair.

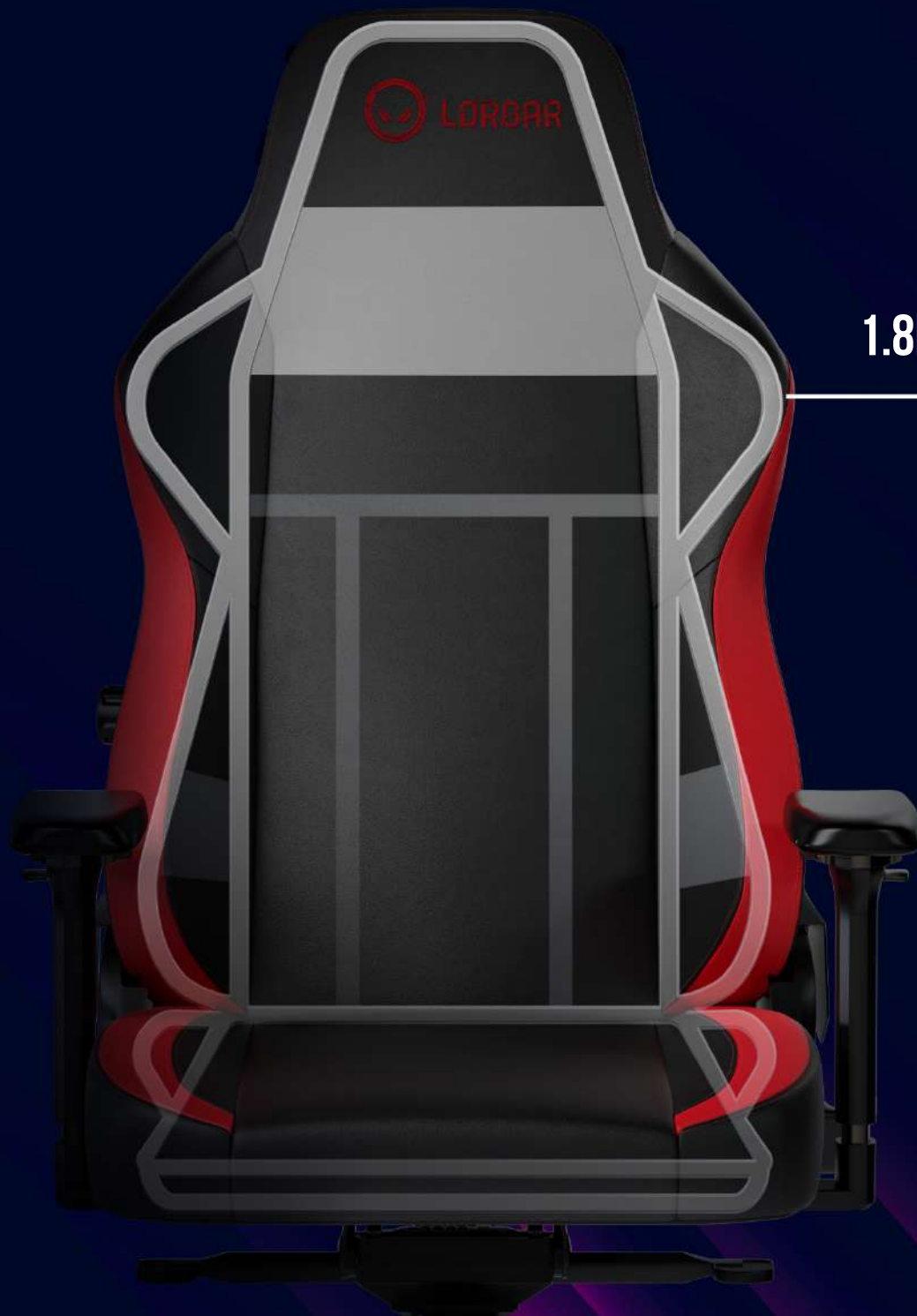

1.8MM

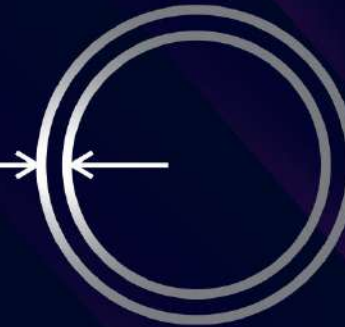

METAL FRAME

We used precision robotic welding to put together the frame. With a metal thickness of 1.8mm, it will serve you for years and years without any deformation. You're probably leaving this chair for your grandkids.

4D



REINFORCED 4D ARMRESTS

The armrests are adjustable to your liking with four degrees of freedom. We guarantee you'll be able to find a comfortable armrest position just for you. You can rely on them – the metal base is sturdy enough to withstand the load.



CLASS 4 GAS LIFT

An integral part of any gaming chair, the Class 4 Gas Lift ensures long-lasting operation with a constant load of 150 kilograms.

MULTIBLOCK MECHANISM

The rocking mechanism allows you to kick back and even lock any inclined angle for your seat between 0° and 13°.





155°

**90° – 155°
ADJUSTABLE BACKREST**

Whether you are at your peak productivity, casually gaming, or watching some content & chilling – you are provided with a respectable range of backrest adjustments. Well, you can even sleep in this chair if you want to.



BUILT-IN FLEXIBLE LUMBAR SUPPORT

The backrest has flexible support for your lower back during longer gaming sessions — adjust it to your liking and comfort. Forget about annoying DIY solutions with our state-of-the-art innovative built-in system. Keep your posture like a pro.

HEADREST PILLOW

A removable headrest pillow reduces neck, head, and shoulder fatigue. It is so comfy you want to carry it everywhere.





ALUMINIUM ALLOY FIVE-STAR BASE

A five-star alloy base is dependable. It is sturdy, stays stable, and provides even contact with the surface.

LARGE 75MM PU CASTERS

Sizeable casters made of soft-touch material will roll around easily while also being gentle on the floors.





COLOUR OPTIONS

The Lorgar Embrace 533 is offered in two colour choices – pick one that looks best to you.

●	LRG-CHR533B		black		5291485010317
●	LRG-CHR533BR		red		5291485010324

TECHNICAL FEATURES



High-Quality PU Eco-leather



1.8mm metal frame



4D adjustable armrests



90° – 155° adjustable backrest



Multiblock mechanism



Built-in Flexible Lumbar Support



5-star aluminium base



75mm PU casters



Class 4 gas lift



User's height –
160 cm-185 cm



Maximum weight
of chair loading



Dimensions & weight –
1250-1320 x 570 x 490 mm,
25.2 kg



Package list –
chair, headrest support pillow



GRACE 855

Gaming chair



GRACE 855 GAMING CHAIR

Never settle for less with this Lorgar Grace 855 gaming chair. Built around a BIFMA-certified* aluminium frame, it offers the ultimate user experience. With the breathable mesh instead of traditional upholstery, you can stay cool and comfortable in any condition. We put a lot of engineering thought into this model. It has a curved frame and reclining 3D armrests. There you can find controls for the heavy-duty Class 4 Gas Lift, which provides smooth and stable operation, not to mention the 18° seating tilt. You can also lock the tilt at any angle you'd like to. The backrest allows for a 112° recline, with the lumbar and headrest support adjustment system.

The five-star base is also made of aluminium alloy, providing excellent stability. It has 60mm PU casters attached that move smoothly and quietly on any surface. These are very gentle on the floors due to the soft-touch material covering the centrepiece. For us, proper gaming chair design isn't just about comfort. It's about the care for our customers' well-being.



Aluminium base and frame



Ergonomic design



Ventilated cover mesh



Maximum loading

*BIFMA is the international not-for-profit trade association for business and institutional furniture manufacturers. BIFMA-certified means that the chair has passed the tests for safety and durability and has been certified to meet BIFMA standards.



BREATHABLE MESH MATERIAL

The frame of the Lorgar Grace 855 gaming chair is covered with breathable mesh. It means comfort for your body, easy care, and it looks cool.



BIFMA-CERTIFIED ALUMINIUM FRAME

High-grade aluminium is used here to provide outstanding durability. The curved frame allows for an unmatched seating experience.



3D

REINFORCED 3D ARMRESTS

The armrests are padded with premium soft-touch material. They are adjustable to your liking, and you can recline them along with the backrest.



CLASS 4 GAS LIFT

An integral part of any gaming chair, the BIFMA-certified heavy-duty Class 4 Gas Lift guarantees smooth operation and can withstand a constant load of 150 kilograms.

MULTIBLOCK MECHANISM

The rocking mechanism lets you kick back and lock any tilt angle for your seat of up to 18°.

18°



Tilt tension
adjustment



112°

90° – 112° BACKREST RECLINE

For any activity, select the right recline angle – sometimes, it is important just to listen to your body, kick back, and relax.



SEAT UNDER-THIGH SUPPORT

There is horizontal seat position adjustment for optimal thigh support, designed to ensure comfort for people of all shapes and sizes.

ADJUSTABLE LUMBAR AND HEADREST SUPPORT

The backrest has a flexible support system for your lumbar and head - perfect for longer gaming sessions. These are definitely helping you to fight fatigue!





ALUMINIUM ALLOY FIVE-STAR BASE

A five-star alloy base is dependable. It is sturdy, stays stable, and provides even contact with the surface.

60MM PU CASTERS

These premium-quality casters roll quietly and easily due to the smart engineering and ball bearings inside. An alloy centrepiece is covered with a soft-touch material – never expect even the slightest damage to your floor.



60MM



COLOUR OPTIONS

The Lorgar Grace 855 comes in two colours, so you can pick one that fits most.

●	LRG-CHR855B		black		5291485010348
●	LRG-CHR855RB		red		5291485010331

TECHNICAL FEATURES



Breathable Mesh Material



BIFMA-certified aluminium frame



3D adjustable armrests



90° – 112° adjustable backrest



Multiblock mechanism



Adjustable Lumbar
and Headrest Support



5-star aluminium base



60mm PU casters



Class 4 gas lift



User's height –
160 cm-205 cm



Maximum weight of chair loading



Dimensions & weight –
1085-1315 x 700 x 590 mm, 26 kg

GAMING CHAIRS PORTFOLIO



	BASE 311	ACE 422	EMBRACE 533	GRACE 855
Mechanism	Multiblock	Multiblock	Multiblock	Multiblock
Armrests	4D adjustable	4D adjustable	4D adjustable	3D adjustable
Base	5-star aluminium	5-star aluminium	5-star aluminium	5-star aluminium
Casters	5 pcs, 75mm PU	5 pcs, 75mm PU	5 pcs, 75mm PU	5 pcs, 60mm PU
Material	PU Eco-leather	Fabric	PU Eco-leather	Mesh
Frame	1.8 mm aluminium	1.8 mm aluminium	1.8 mm aluminium	Aluminium
Gas lift	Class 4	Class 4	Class 4	Class 4
Head support	Pillow	Pillow	Pillow	Adjustable
Lumbar support	Pillow	Pillow	Adjustable	Adjustable



GAMING ACCESSORIES

WEB- CAMERAS





RAPAX 701

Webcamera



RAPAX 701 WEBCAMERA

The world should see you through our Lorgar Rapax 701 web camera. With 6 built-in lenses and features like autofocus, auto white balance, low brightness compensation, and exposure correction, it brings a level of clarity you haven't seen before. A high-performing CMOS Imaging Sensor provides video quality up to 2560x1440p (QUAD HD) at 30fps and 1920x1080p (Full HD) at 60fps. Whether gaming, working, or chatting, you'll get a pixel-perfect image plus an optimized viewing angle. A few more things: our Lorgar Rapax 701 camera is equipped with highly sensitive stereo microphones covering 30 to 300 cm speech distances. A privacy shutter, 360-degree rotation, and angle setting are also included. You can easily mount the camera on your monitor or place it on a tripod. With Plug & Play technology support, it takes minutes to set your device up and get started. What's more a web camera can offer?



Video quality



High-performance CMOS



Plug & Play connection



6 BUILT-IN LENSES

A combination of six lenses with varying characteristics allows for high image quality.



HIGH-PERFORMANCE CMOS IMAGING SENSOR

High-resolution optics provide benchmark detail and let you record videos of QUAD HD quality.

DIGITAL ZOOM

4x digital zoom enables you to adjust the image regardless of where the camera is mounted.

4X

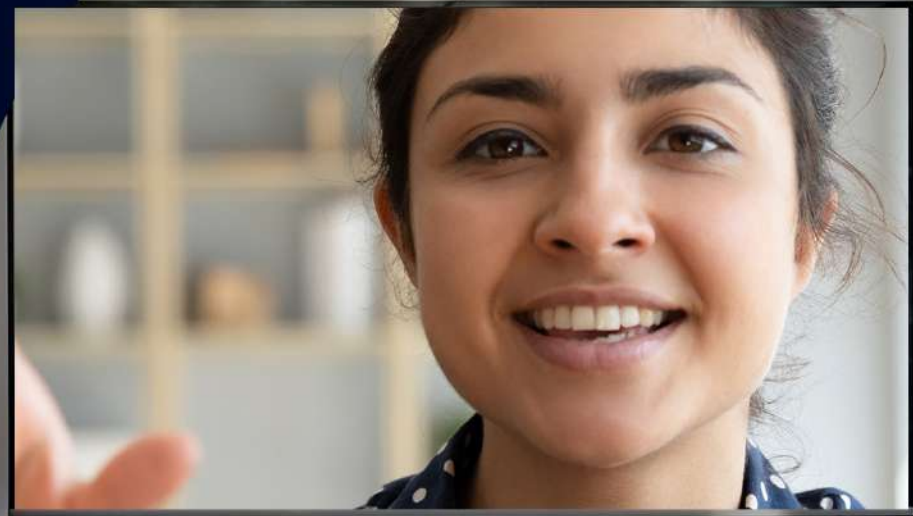



STEREO MICROPHONES

Omni-directional and high-sensitive microphones register sound at distance up to 3 meters.



PRIVACY SHUTTER

Maintain your privacy while the camera is not in use.



UNIVERSAL MOUNT

With a built-in universal mount, you can easily place the camera on your laptop, desktop or desk. 360-degree rotation and vertical angle setting allow you to stay in focus at all times. The device also has a standard 3/8" screw mount for your tripod (not included).

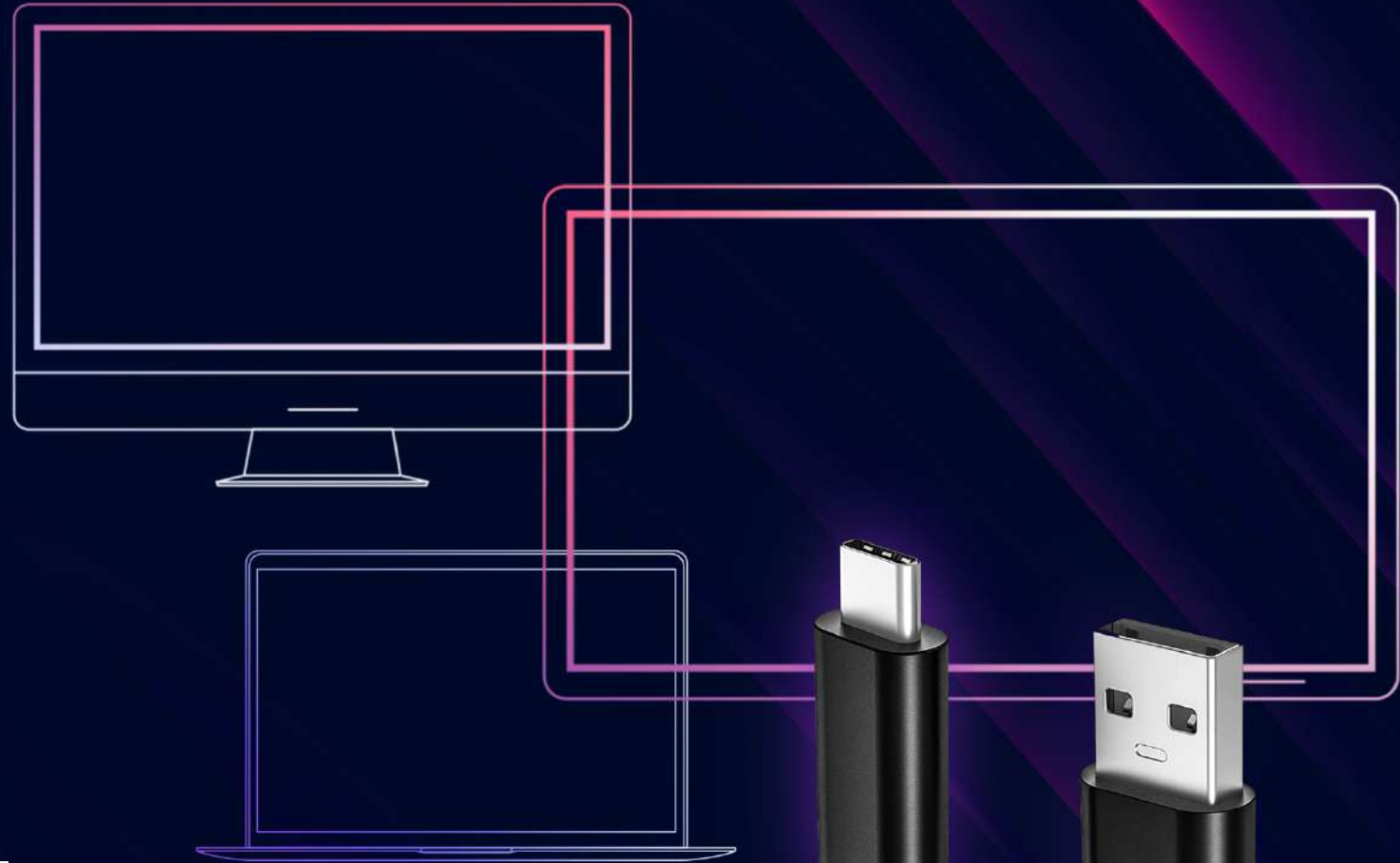

TYPE-C CABLE

Plug & Play technology support lets you set the camera up fast and get going – no special skills or additional software required. Stay flexible and place your camera wherever you want with a 2-meter USB-cable.

AVAILABLE IN 3 COLORS

Pick your preferred color of Rapax 701:
blue, white, or pink.



●	LRG-SC701PK		black/pink		5291485009274
●	LRG-SC701WT		black/white		5291485009250
●	LRG-SC701BL		black/blue		5291485009267



KEYCHAIN INSIDE

Don't forget to get your keychain from Lorgar before you dispose of the packaging!





KEY FEATURES



Automatic white balance, low brightness compensation and exposure correction



Built-in stereo microphones



75 degree viewing angle 2K / 60fps gaming camera



Universal mount for all monitors, laptops and TV



Sony sensor inside



Support tripod mounting



Professional Auto focus



Smart TV or TV box support



4X Digital zoom at HD720p



Compatible with Windows,



Android 5.0 or above,



macOS 10.6 or above



Equipped with privacy shutter



Type-C cable connection



CIRCULUS 910

Live streaming web camera





CIRCULUS 910 LIVE STREAMING WEB CAMERA

Shine bright with the Lorgar Circulus 910 web camera. Built around a Sony® STARVIS™ CMOS sensor and a full-glass lens, this camera brings an image quality seldom seen in web cameras. It performs like a champ: record 1080P video at 60FPS, with an option of 3x digital zoom and professional autofocus technology.

But hold on – this is a 2-in-1 camera! It is equipped with a ring light that makes any place look like a studio. The brightness and colour temperature are adjustable on the go, and so is the orientation. You can also use it as a desk lamp – just tilt it forward. Stereo mics with active noise reduction guarantee that your voice will sound amazing.

A magnetic privacy cover conveniently attaches to the back of the camera when you take it off the lens.

Connect your Circulus 910 webcam with a Type-C cable and get this show on the road. The camera is perfectly compatible with Android, macOS, Windows, and SmartTV. The tripod is included, and you'll like it a lot! With the wide range of motion, you'll be able to put it behind your 13" laptop or a large gaming monitor at home. The tripod is also foldable and has a standard thread so that you can use it with the other accessories. Build a bolder image with Lorgar Circulus 910!



60 fps



Glass lens



Ring light

● ● LRG-SC910 | black/white | 5291485009311



IMAGE QUALITY

The 1/2.8" Sony® STARVIS™ CMOS sensor and a full-glass lens provide excellent image quality.



5MP

CAPABILITIES

The 5 MP sensor allows you to record videos in the maximum resolution of 2592×1944. Capture FullHD 1080P video at 60FPS, utilise 3x digital zoom, smart autofocus, automatic exposure, and automatic white balance.

RING LIGHT

The 5.5 inch built-in ring light with 36 LEDs ensures excellent lighting in any condition. Adjust brightness and colour temperature (1 700 K–14 000 K), or tilt it and just let it be an additional lighting source for your workspace.

DAY



COOL WHITE



WARM



TRIPOD

A universal tripod is included in the package. Foldable and compact, it can extend from 20 cm up to 73 cm. The standard thread allows you to use it with other accessories.





STEREO MICROPHONES

Two microphones with active noise reduction provide an unmatched clarity of speech.



MAGNETIC PRIVACY COVER

We added a convenient magnetic lens cover if you want absolute privacy. It also attaches to the back of the camera, so you don't have to worry about losing it.

CONNECTION AND COMPATIBILITY

Type C is our favourite connection: universal, fast, and reliable. It secures the lossless video stream to any device.

Speaking of devices, the camera is compatible with most platforms:

- Android 5.0 or higher;
- macOS 10.6 or higher;
- Windows® 7, Windows 8.1, Windows 10 or higher;
- also compatible with SmartTV.



Windows



macOS



Android



SmartTV



KEYCHAIN INSIDE

Don't forget to get your keychain from Lorgar before you dispose of the packaging!



TECHNICAL FEATURES



Automatic white balance and exposure correction



80 degree viewing angle, 5MP 2592x1944 / 60fps camera

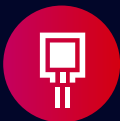

Sony® STARVIS™ CMOS sensor inside



6 glass lens



5.5-inch ring light with colour temperature and brightness adjustment



Professional auto focus



3X Digital zoom



Equipped with magnetic privacy cover



Built-in stereo microphones



Foldable tripod included



Smart TV or TV box support



Compatible with Windows, Android 5.0 or above, macOS 10.6 or above



Type C cable connection

LIVE STREAMING WEB CAMERAS PORTFOLIO



	RAPAX 701	CIRCULUS 910
Resolution, max	2K QHD 2560x1440	5MP 2592x1944
FPS, max	60	60
Lens	6 built-in lens	6 glass lens
Mics	Stereo/noise reduction	Stereo/noise reduction
Autofocus	Yes	Yes
FOV	83°	90°
Privacy	Shutter	Magnetic cover
Embedded light	No	5.5-inch built-in ring light



GAMING ACCESSORIES

MICROPHONES





SONER 313

Professional Microphone



SONER 313 PROFESSIONAL MICROPHONE

Chat with teammates during game battles, host streams and work meetings, record podcasts, and enjoy the great sound quality brought to you by Lorgar!

The Soner 313 USB Microphone is a simple and affordable way to get a 48 kHz reference frequency at 16 bit. The microphone has a cardioid polar pattern, ensuring clear voice transmission due to suppression of external sounds and noise. The sensitivity of the gadget is approximately 40 dB, and the operating frequency range is from 80 Hz to 17 kHz. The volume and sound quality are easy to adjust due to the comfortable location of controllers. The microphone stand is stable and allows you to position the microphone at the desired angle quickly. A fully detachable 2.5 m USB cable with plugs at both ends is used for a connection. The device does not require additional software or special skills - all you have to do is connect a microphone to the USB input of your computer and start chatting. The design of the lower part of the device allows it to be used with additional pantographs and tripods. The best solution for a comfortable game and work!

- High quality sound
- Plug & Play
- Compatible with Mac, Windows, Android and Sony PlayStation
- Supports Discord, OBS, FL Studio, Skype etc.
- Cardioid polar pattern
- Solid metal design
- Volume wheel
- Echo wheel
- 2.5 m USB cable A-male to B male
- Tripod included



● LRG-CMT313 | black | 5291485008369

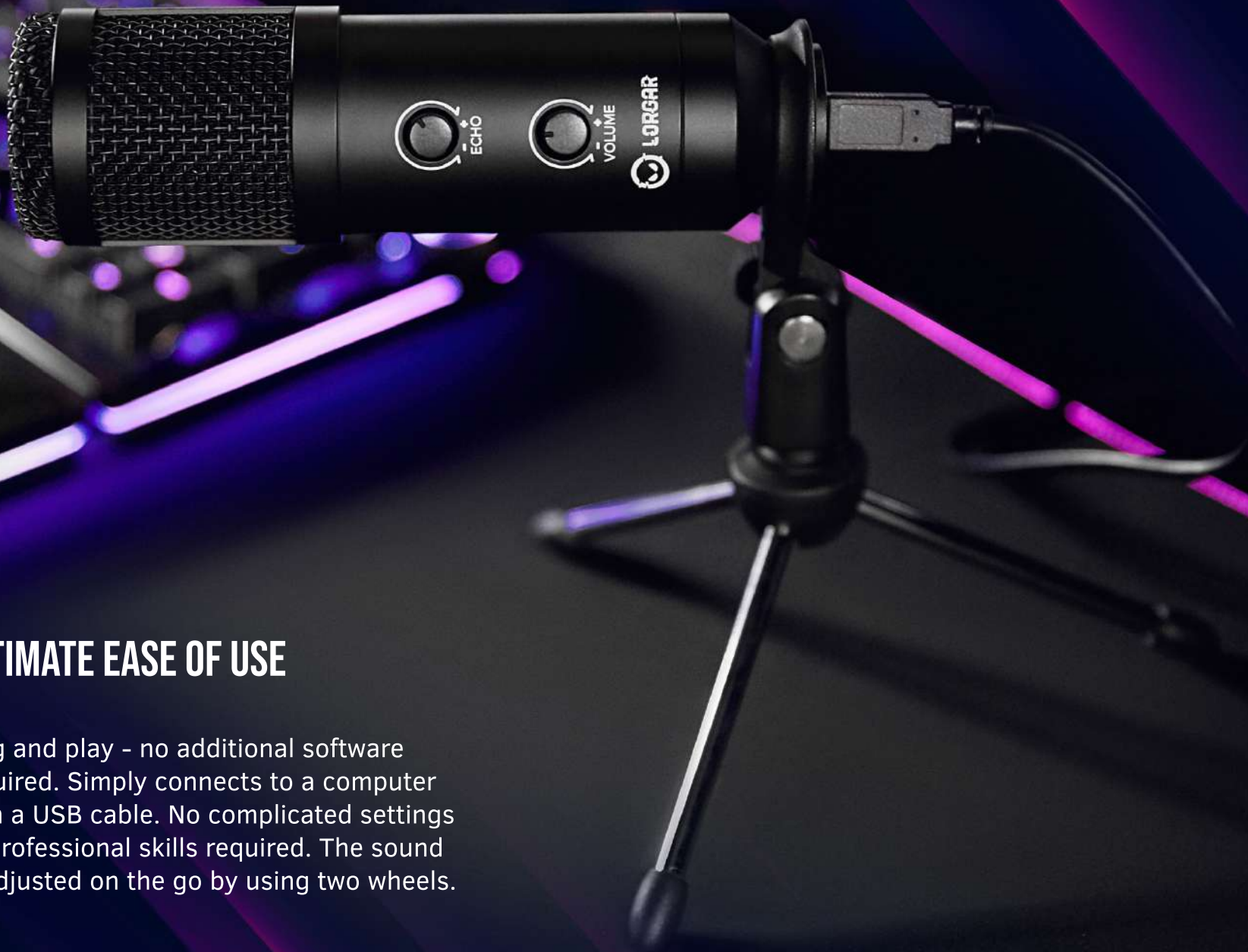

ULTIMATE EASE OF USE

Plug and play - no additional software required. Simply connects to a computer with a USB cable. No complicated settings or professional skills required. The sound is adjusted on the go by using two wheels.

A WIDE RANGE OF APPLICATIONS

Suitable for all microphone use cases. In-game communication, streaming, podcast recording, work meetings. Supports Discord, OBS, FL Studio, Skype, and other programs.

Compatible with Mac OS, Windows, Android, and PlayStation.



OMNI-DIRECTIONAL CARDIOID PATTERN

Picks up sound from the front and eliminates all noises from the sides. Engineered for high-quality voice recordings. Recommended for online gaming, streaming & podcast recording.



DEVICE DESCRIPTION

Echo wheel to reduce reverberation and control sound clarity

Durable metal body, high-quality build

Volume wheel for fast and accurate volume control

Easy adjustment of height, tilt and swivel

Stable tripod stand





TECHNICAL PARAMETERS

Power supply: 5 V

Polar pattern: Unidirectional (cardioid)

Frequency response: 80Hz - 17KHz

Sensitivity: -40 dB \pm 3 dB

Maximum sound pressure level: 130dB

(at 1kHz \leq 1% T.H.D)

Signal-to-noise ratio: 78 dB

Sampling rate: 48 kHz

Electrical Current: 35 mA \pm 5 mA

MATERIALS AND DIMENSIONS

Materials: ABS plastic, metal

Product dimensions: 129.1 x 176.0 x 120.6 mm

Package dimensions: 47.4 x 158.2 x 48.1 mm

Product weight: 243 g



VOICER 521

Professional Microphone



VOICER 521

PROFESSIONAL MICROPHONE

The Lorgar Voicer 521 is the first microphone in the Lorgar premium line. You can confidently use it for all your needs – game battles, work meetings, recording podcasts, or streaming. Thanks to the “Tap-to mute” touch button on the microphone, you can instantly mute the sound with a light touch. A sound indicator will show whether you went live. The built-in sound card allows you to connect headphones directly to the microphone and monitor recording progress without booting up your computer or recorder. It offers an optimal audio format of a reference frequency of 48 kHz, with a bit rate of 16 bits.

The microphone has a cardioid polar pattern, ensuring clear voice transmission due to suppression of external sounds and noise. The gadget has optimal sensitivity - about 40 dB and a wide range of operating frequencies - from 50 Hz to 18 kHz. Adjusting the volume and quality of the sound, output signal level, and instant mute are quick and intuitive. The microphone stand is stable and quickly positions the microphone at the desired angle and rotates 360°. A fully detachable USB Type-C cable 2 m long with plugs at both ends is used for the connection. The gadget does not require additional software or special skills - just connect the microphone to the USB input of your computer and start recording!

- Professional sound
- Robust metal construction
- Plug & Play
- Volume and sensitivity control
- Compatible with Mac OS, Windows, Android, and PlayStation
- Tap-to-mute touch button for instant mute
- Supports all popular software for audio communication and streaming
- Microphone status indicator
- Connects to headphones
- Output level control directly on the microphone
- Cardioid polar pattern
- Fully detachable 2m USB Type-C cable
- 360° adjustable tripod included



○ LRG-CMT521 | black | 5291485008376

ULTIMATE EASE OF USE

Plug and play - no additional software required. Simply connects to a computer with a USB cable. No complicated settings or professional skills required. The sound is adjusted on the go.



A WIDE RANGE OF APPLICATIONS

Suitable for all microphone use cases. In-game communication, streaming, podcast recording, work meetings. Supports Discord, OBS, FL Studio, Skype, and other programs.

Compatible with Mac OS, Windows, Android, and PlayStation.



OMNI-DIRECTIONAL CARDIOID PATTERN

Picks up sound from the front and eliminates all noises from the sides. Engineered for high-quality voice recordings. Recommended for online gaming, streaming & podcast recording.

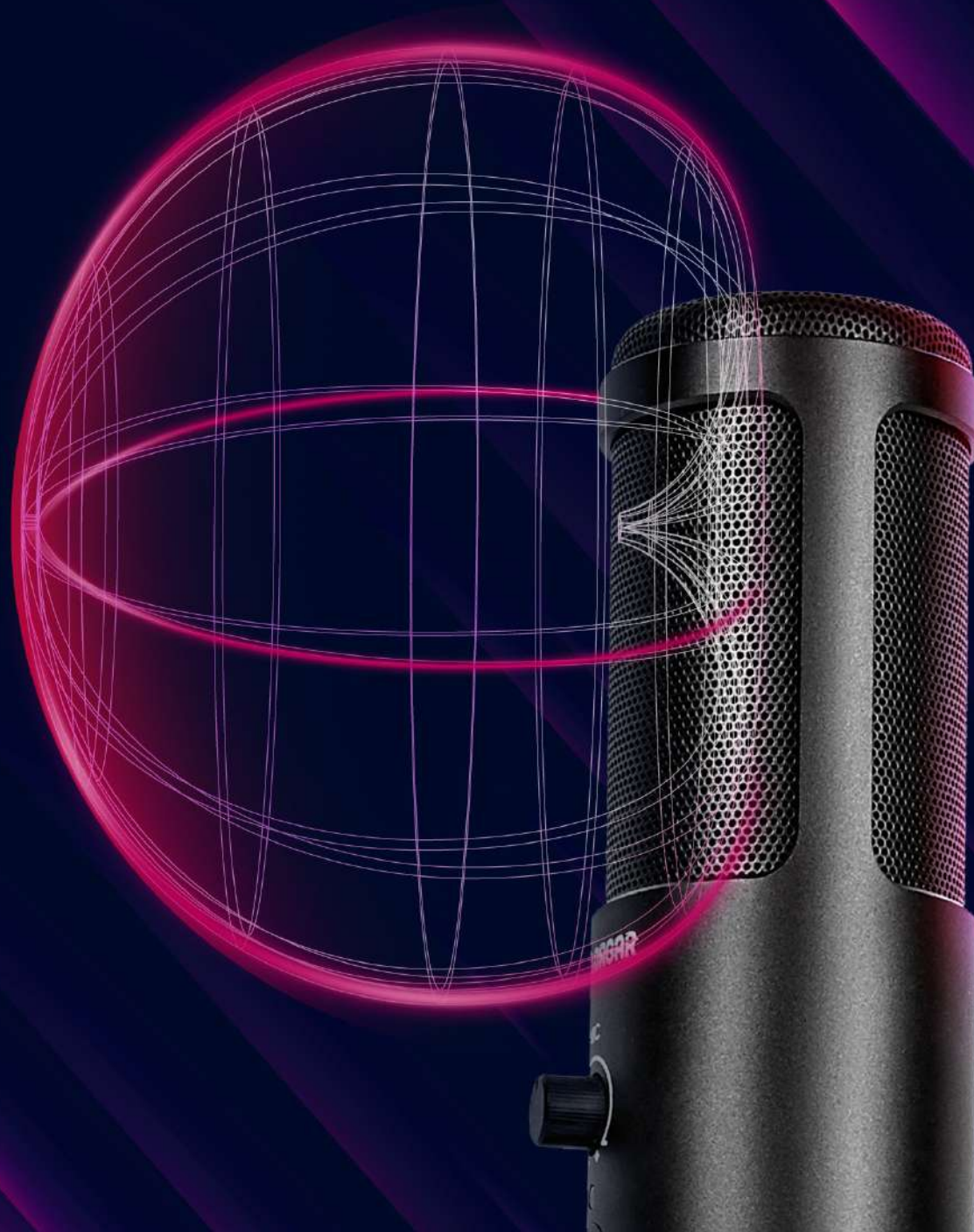

TOUCH BUTTON WITH LED INDICATOR

Tap-to-mute touch button to disable or enable your mic, and LED status indicator for letting you know whether or not you are on air right now.



DEVICE DESCRIPTION

Volume wheel for fast and accurate volume control

LED indicator to track mute/unmute status

Tap-to-mute touch button

Durable metal body, high-quality build

Easy adjustment of height, tilt and swivel

Stable tripod stand

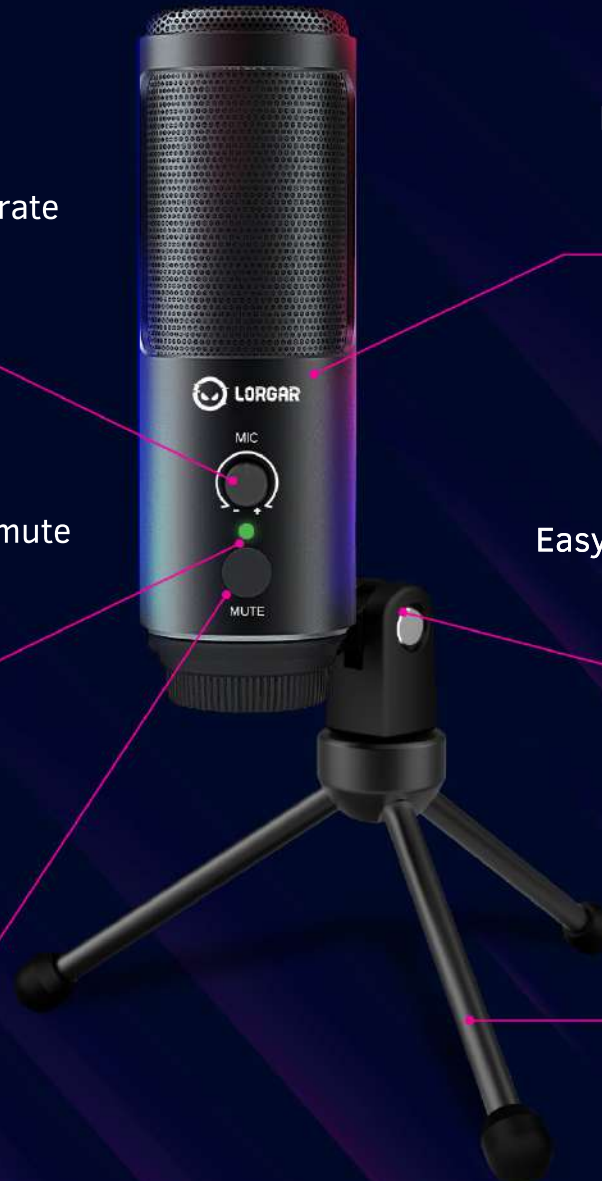



TECHNICAL PARAMETERS

Power supply: 5 V

Polar pattern: Unidirectional (cardioid)

Frequency response: 50 Hz - 18 kHz

Sensitivity: $-40 \text{ dB} \pm 3 \text{ dB}$

Maximum sound pressure level: 110 dB (at 1kHz \leq 1% T.H.D)

Load impedance: 1000 Ω

Signal-to-noise ratio: 70 dB (A-weighted)

Sampling rate: 44.1K / 48 kHz

Electric current: 75mA \pm 5mA

Recording format: 48 kHz 16 bit

MATERIALS AND DIMENSIONS

Materials: ABS plastic, metal

Product dimensions: 136 x 101 x 136 mm



VOICER 721

Professional Microphone



VOICER 721

PROFESSIONAL MICROPHONE

Want your gaming streams and recordings to sound better?

The Voicer 721 by Lorgar is designed specifically for gamers and will provide a reference voice transmission rate of 48 kHz, with a bit rate of 16 bit. In addition, the microphone has a cardioid polar pattern, ensuring clear voice transmission due to suppression of external sounds and noise.

The sensitivity of the gadget is approximately 40 dB, and the operating frequency range is from 50 Hz to 18 kHz. Adjusting the volume and sound quality is quick and handy. This "Plug & Play Package" offers everything you need for quick setup and work: 2m USB Type-C cable, tripod, shock mount, and mounting accessories. A shock mount, pop filter, and foam windscreen will improve the quality of voice recording by blocking extraneous noise from air and vibrations. The tripod is extremely stable and allows you to position the microphone at the desired angle quickly. The microphone is compatible with most popular programs and does not require additional software or special skills to use. Maximum convenience for creativity and communication!

- Professional sound
- Plug and Play system
- Cardioid polar pattern
- Nickel-plated diaphragm
- Volume control
- Mute button with LED indicator
- 360° Rotation & 180° Tilt
- Headphone out - jack 3.5 mm
- The kit includes 2 m USB-C cable, tripod stand, shock mount, windscreen cap, 3/8" to 5/8" universal pantograph adapter, pop filter, tripod mount ring
- Compatible with Mac, Windows, Android and PlayStation
- Supports Discord, OBS, FL Studio, Skype, etc.



● LRG-CMT721 | black | 5291485008383

ULTIMATE EASE OF USE

Plug and play - no additional software required. Simply connects to a computer with a USB cable. No complicated settings or professional skills required. The sound is adjusted on the go.



A WIDE RANGE OF APPLICATIONS

Suitable for all microphone use cases. In-game communication, streaming, podcast recording, work meetings. Supports Discord, OBS, FL Studio, Skype, and other programs.

Compatible with Mac OS, Windows, Android, and PlayStation.



OMNI-DIRECTIONAL CARDIOID PATTERN

Picks up sound from the front and eliminates all noises from the sides. Engineered for high-quality voice recordings. Recommended for online gaming, streaming & podcast recording.



HIGH-QUALITY RECORDING

A shock mount and "gooseneck" pop filter will improve the quality of voice recording.



TOUCH BUTTON WITH LED INDICATOR

Tap-to-mute touch button to disable or enable your mic, and LED status indicator for letting you know whether or not you are on air right now.



LOGITECH

MIC



MUTE

DEVICE DESCRIPTION

Volume wheel for fast and accurate volume control

Isolates your mic from sound & vibration

LED indicator to track mute/unmute status

Tap-to-mute touch button

Efficiently reduce air blasts, wind interference, saliva spraying during your recording or broadcasting

Durable metal body, high-quality build

Headphone out - jack 3.5 mm

The pop filter has a flexible 360° gooseneck clip stabilizing arm

Easy adjustment of height, tilt and swivel

Stable tripod stand



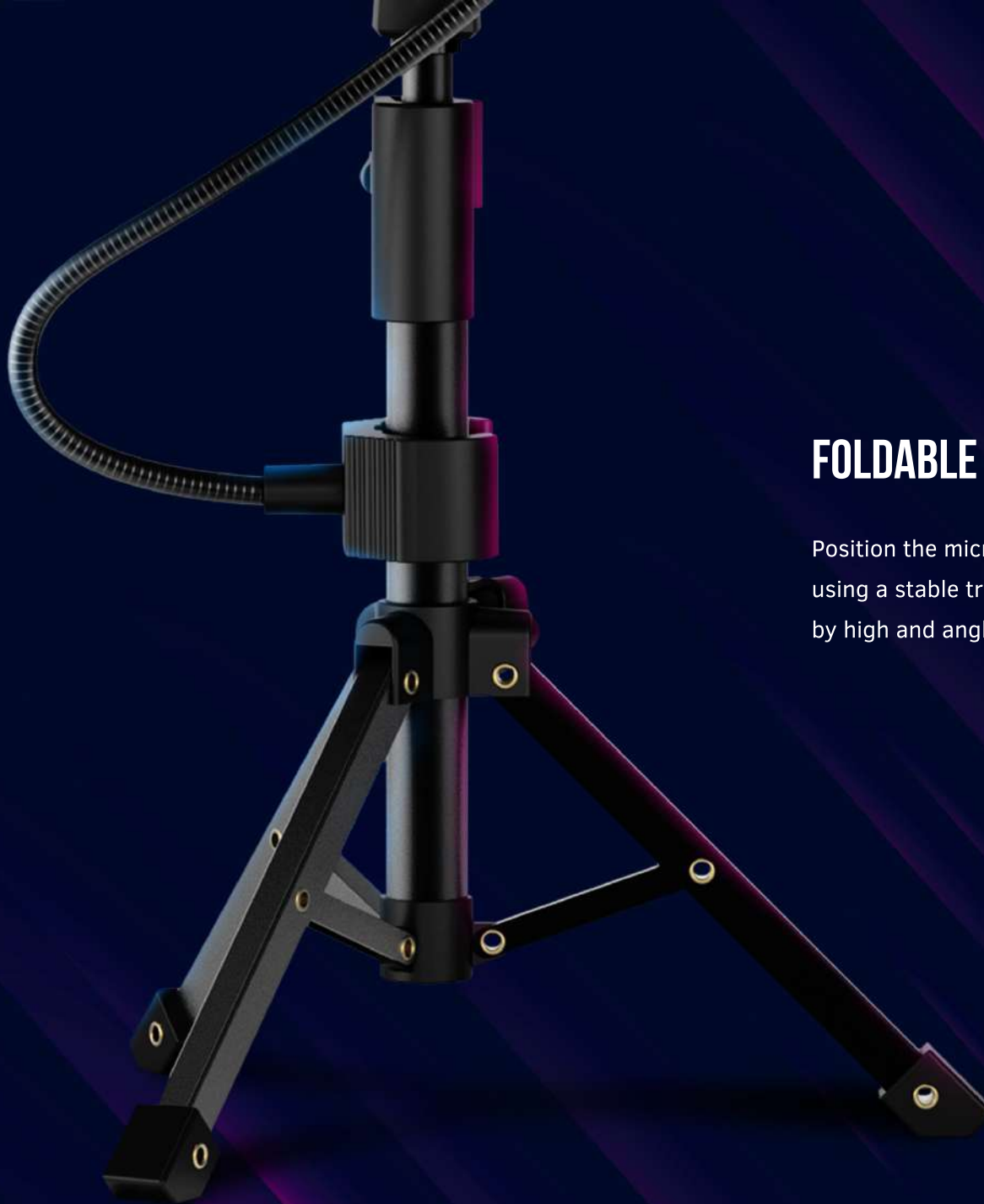

FOLDABLE TRIPOD

Position the microphone quickly using a stable tripod adjustable by high and angle.



FULL KIT CONTENT

Microphone with cardioid polar pattern

2 m USB-C cable

Tripod stand & Tripod mount ring

Shock mount

Windscreen cap

3/8" to 5/8" universal pantograph adapter

Pop filter

TECHNICAL PARAMETERS

Frequency response: 50 Hz — 18 kHz

Sensitivity: -40 dB ± 3 dB

Polar pattern: Uni-directional

S/N Ratio: 70 dB (A-weighted)

Power Supply: 5V

Max.SPL: 110 dB (at 1 kHz ≤1% T.H.D)

Sampling rate: 44.1K / 48kHz

Recording format: 48 KHz / 44.1 KHz, 16bit

Electrical current: 70±5mA



VOICER 931

Professional Microphone



VOICER 931

PROFESSIONAL MICROPHONE

This compact, multifunctional set from Lorgar is made for gamers who want to stream, record videos or podcasts. Voicer 931 will provide a reference voice transmission rate of 48 kHz, with a bit rate of 16 bits. In addition, the microphone has a cardioid polar pattern, ensuring clear voice transmission due to suppression of external sounds and noise. The sensitivity of the gadget is approximately 40 dB, and the operating frequency range is from 50 Hz to 18 kHz. Sound control has been optimized for maximum ease of use. Pop filter and shock mounting eliminate sound vibrations and noise. All the accessories included in the kit allow you to record in any place. The pantograph stand will help you comfortably position the microphone on any table, and the adjustable tripod will allow you to record in any position. Both stands are supplied with all the necessary adapters and mounts. The microphone is compatible with most programs and does not require additional software or skills to use.

The perfect gadget for your creative ideas!

- Professional sound
- Tap-to-mute button with LED indicator
- Plug and Play system
- Output level controls located directly on the microphone
- Sturdy metal design
- 360° Rotation & 180° Tilt
- Cardioid polar pattern
- The kit includes microphone, 2.5 m USB-A to Type-C cable, tripod stand, desktop boom arm, pivot mount, shock mount, shock mount ring, c-clamp, 3/8" to 5/8" universal pantograph adapter, pop filter
- Nickel-plated diaphragm
- Compatible with Mac, Windows, Android and PlayStation
- Passive sound protection: detachable pop-filter and shock mount diaphragm
- Supports Discord, OBS, FL Studio, Skype, etc.
- Volume control



LRG-CMT931 | black | 5291485008390



ULTIMATE EASE OF USE

Plug and play - no additional software required. Simply connects to a computer with a USB cable. No complicated settings or professional skills required. The sound is adjusted on the go.

A WIDE RANGE OF APPLICATIONS

Suitable for all microphone use cases. In-game communication, streaming, podcast recording, work meetings. Supports Discord, OBS, FL Studio, Skype, and other programs.

Compatible with Mac OS, Windows, Android, and PlayStation.



OMNI-DIRECTIONAL CARDIOID PATTERN

Picks up sound from the front and eliminates all noises from the sides. Engineered for high-quality voice recordings. Recommended for online gaming, streaming & podcast recording.



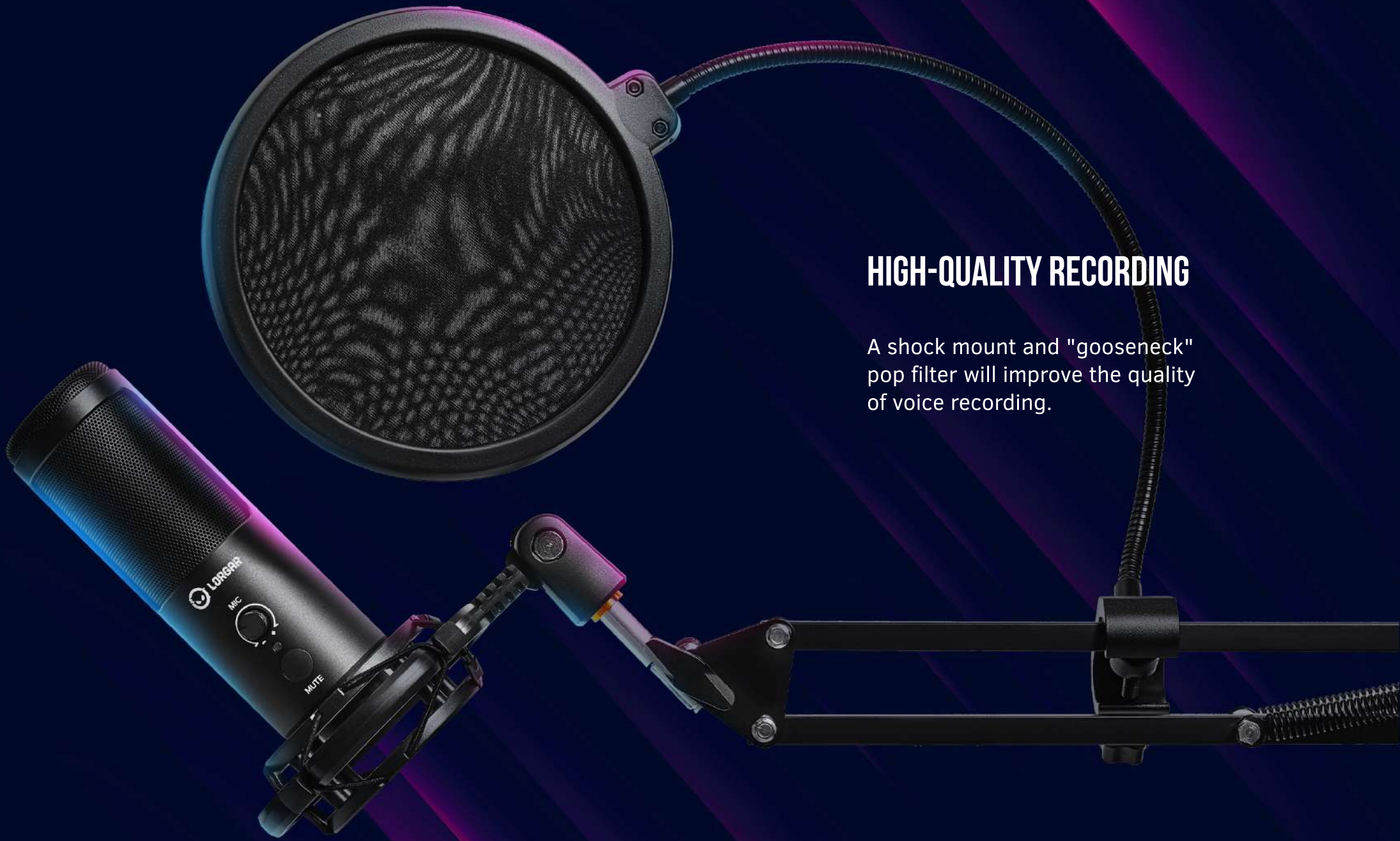

HIGH-QUALITY RECORDING

A shock mount and "gooseneck" pop filter will improve the quality of voice recording.

TOUCH BUTTON WITH LED INDICATOR

Tap-to-mute touch button to disable or enable your mic, and LED status indicator for letting you know whether or not you are on air right now.

 LORGAR

MIC



MUTE

DEVICE DESCRIPTION

Pop filter efficiently reduce air blasts, wind interference, saliva spraying during your recording or broadcasting

The pop filter has a flexible 360° gooseneck clip stabilizing arm

Durable metal body, high-quality build

Volume wheel for fast and accurate volume control

LED indicator to track mute/unmute status

Tap-to-mute touch button

Shock mount isolates your mic from sound & vibration

Headphone out - jack 3.5 mm and sound monitoring wheel

Durable metal arm that you can clip on a desk. Adjustable height, length and direction

Tripod





BEST SETTER

A pantograph allows you to find the best position for your Voicer and save a space at the workplace. A small tripod will help you to use Voicer in case the pantograph is not suitable.

SOUND MONITORING

Live sound monitoring with regulation will help you to adjust your voice to optimal level.

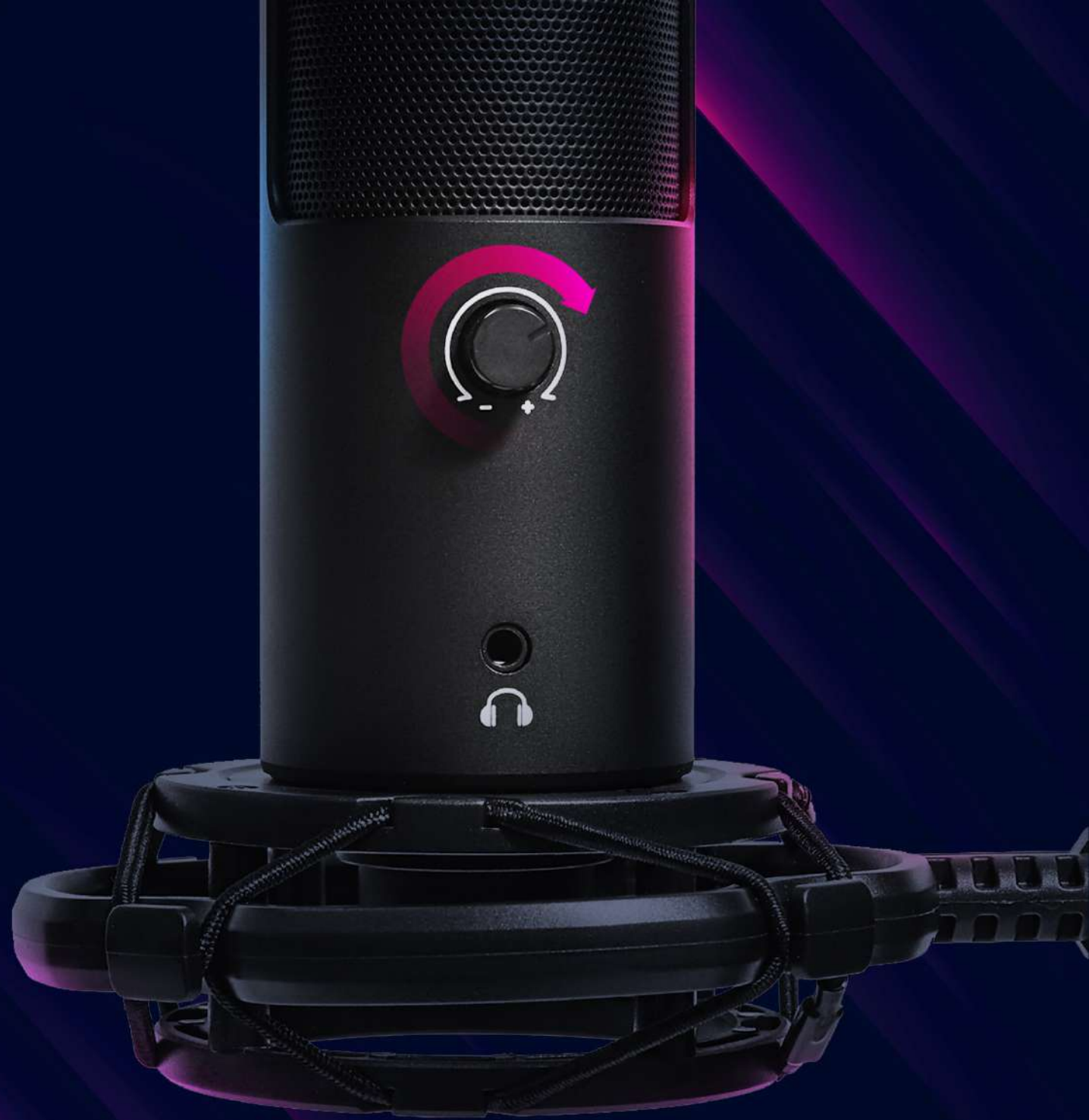

FULL KIT CONTENT

Microphone with cardioid polar pattern

2.5 m USB-A to Type-C cable

Tripod stand

Desktop boom arm

Pivot mount

Shock mount & shock mount ring

C-clamp, 3/8" to 5/8" universal pantograph adapter

Pop filter

TECHNICAL PARAMETERS

Frequency response: 50 Hz — 18 kHz

Sensitivity: -40 dB \pm 3 dB

Polar pattern: Uni-directional

S/N Ratio: 70 dB (A-weighted)

Power Supply: 5V

Max.SPL: 110 dB (at 1 kHz \leq 1% T.H.D)

Sampling rate: 44.1K / 48kHz

Load impedance: 1000 Ω

Bitrate: 16 bit

Electrical current: 70 \pm 5mA



PROFESSIONAL MICROPHONES PORTFOILO



SONER 313



VOICER 521



VOICER 721



VOICER 931

Polar patterns	Cardioid	Cardioid	Cardioid	Cardioid
Frequency response	80Hz – 17kHz	50Hz – 18kHz	50Hz – 18kHz	50Hz – 18kHz
Sensitivity	-40dB	-40dB	-40dB	-40dB
Max. SPL	130dB	110dB	110dB	110dB
S/N ratio	>70dB	70dB	70dB	70dB
Material	Metal	Metal	Metal	Metal
Connection	A male to B male/ 2.5m	Type C/ 2m	Type C/ 2m	Type C/ 2.5m
Tripod	yes	yes	yes, advanced	yes
Pop filter	no	no	yes	yes
Shock mount	no	no	yes	yes
Pantograph	no	no	no	yes
Volume control	yes	yes	yes	yes
Sound monitoring	no	no	no	yes
LED mute indicator	no	yes	yes	yes
Mute button	no	yes	yes	yes
HP 3.5 out	no	yes	yes	yes



GAMING ACCESSORIES

MOUSE PADS





MAIN 133 / 135 / 139

Gaming mouse pads



MAIN 133, MAIN 135, MAIN 139 GAMING MOUSE PADS

These Lorgar gaming mousepads are going to change your perception of control. The Main High-Speed is a series designed for fast mouse movement. Its super glide surface was made possible thanks to the special low-resistance fibres – and you can rest assured the manoeuvrability of your mouse is stellar. Thick 3mm foam with a trimmed edge provides excellent comfort, and the anti-slip rubber base will stay put no matter what. Have no worries about compatibility – all sensor types work with these pads.

This series comes in three sizes: medium, large, and extra large. Choose the one that fits your gaming setup best!



Perfect gliding



Surface type:
speed



Anti-slip
rubber base (3 mm)



Frameless
design

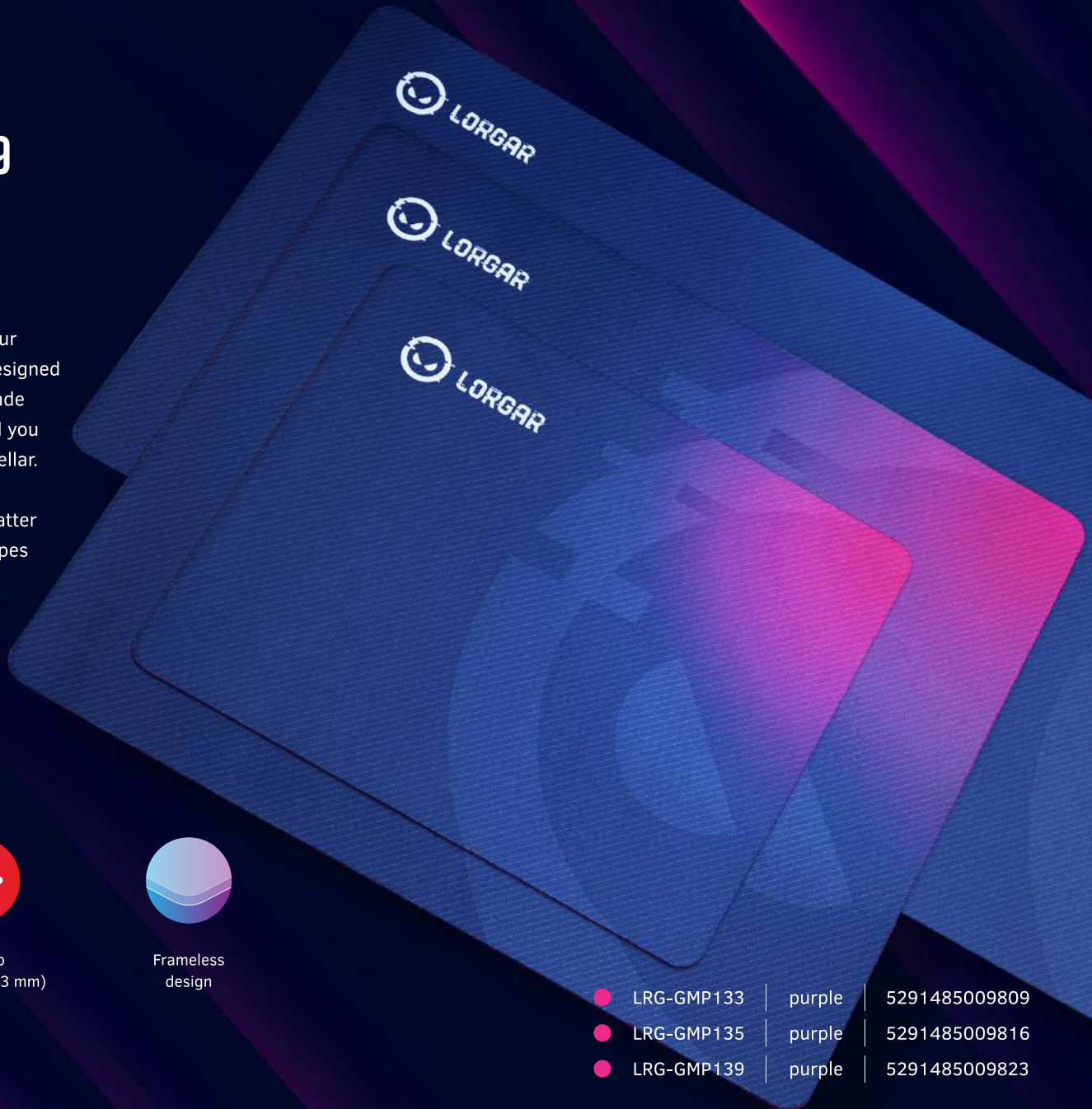

● LRG-GMP133	purple	5291485009809
● LRG-GMP135	purple	5291485009816
● LRG-GMP139	purple	5291485009823

SUPERIOR GLIDE SURFACE

Crafted by the best engineers in the industry, the smooth, low-resistance fibres will make your mouse lightning fast. Super glide surface also ensures excellent manoeuvrability of the controller.





ANTI-SLIP RUBBER BASE

The superior anti-slip rubber base is as good as glue. It is embossed with the Lorgar logo – gives at least +5 points to your skill. With the total pad thickness of 3mm, you'll be extra comfy.



TRIMMED EDGES

The edge is trimmed for a smoother forearm experience.



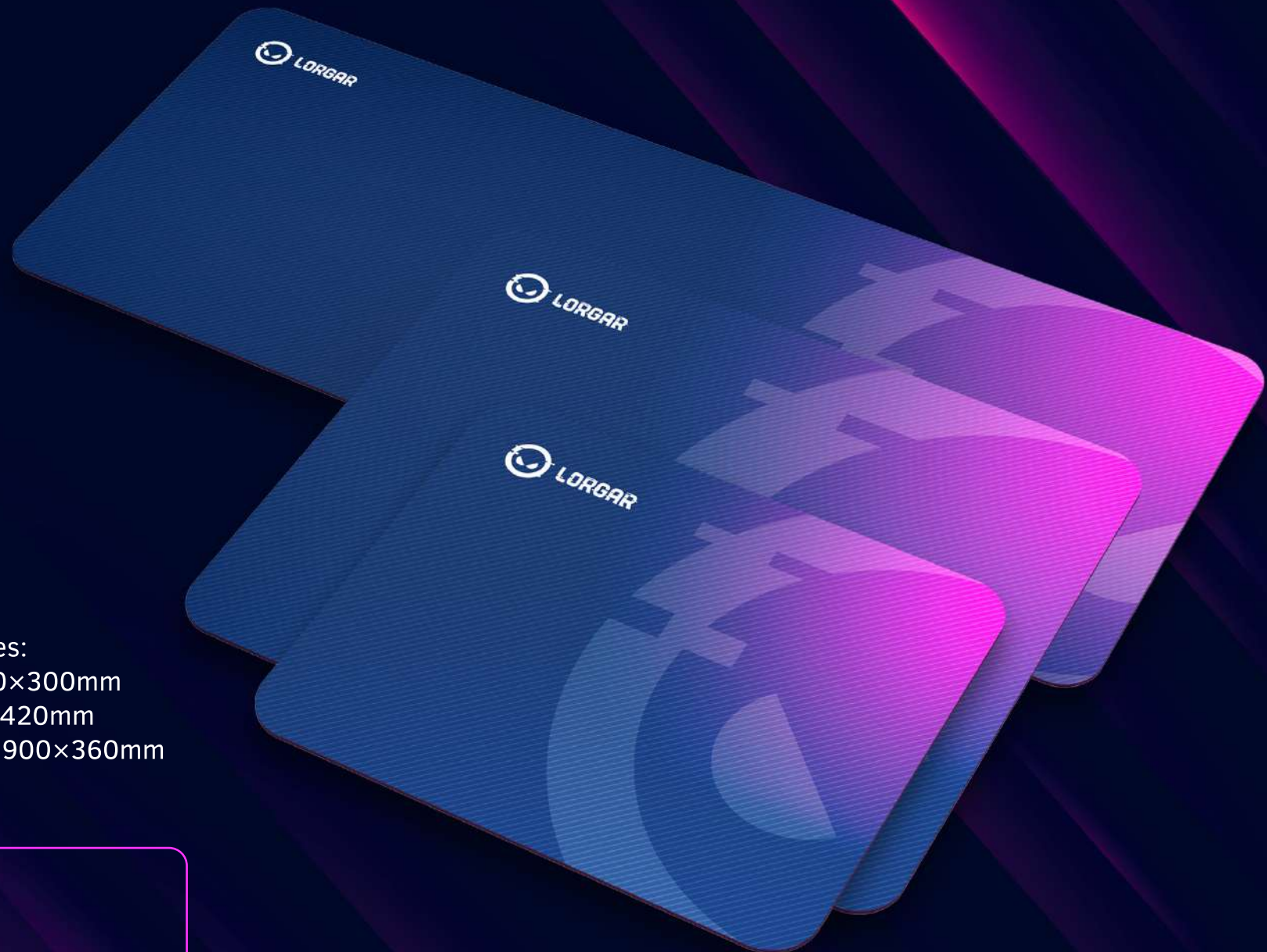

DIFFERENT SIZES

These come in three sizes:

Main 133 – Medium, 360×300mm

Main 135 – Large, 500×420mm

Main 139 – Extra Large, 900×360mm



KEYCHAIN INSIDE

Be sure to retrieve your branded Lorgar keychain before you throw the package away.



TECHNICAL FEATURES

MAIN 133

MAIN 135

MAIN 139

Dimensions	360mm x 300mm x 3mm	500mm x 420mm x 3mm	900mm x 360mm x 3mm
Surface type	High-speed surface with perfect gliding		
Edges	Trimmed edges for maximum comfort		
Base	Superior anti-slip rubber base with unique design		
Compatibility	Optimized for all mouse sensitivities and sensors		



MAIN 313/ 315/319

Gaming mouse pads



MAIN 313, MAIN 315, MAIN 319 GAMING MOUSE PADS

These Lorgar gaming mousepads will change the way you feel movement. We created the Main High-Speed series for you to be faster than your opponents, and that's not the only advantage. The super glide surface was made possible thanks to the special low-resistance fibres – and it feels like the mouse is flying. Thick 3mm foam with a double-stitched edge provides excellent comfort and durability. The anti-slip rubber base won't go anywhere unless you really want to. Don't worry about compatibility: every sensor works fine with these pads.

This series is available in three sizes: medium, large, and extra large. Choose the one to your liking, and go get some frags!



Perfect gliding



Surface type:
speed



Anti-slip
rubber base (3 mm)



Double stitched
edges



● LRG-GMP313	black/purple	5291485009830
● LRG-GMP315	black/purple	5291485009847
● LRG-GMP319	black/purple	5291485009854

SUPERIOR GLIDE SURFACE

Crafted by the best engineers in the industry, the smooth, low-resistance fibres will make your mouse lightning fast. Super glide surface also ensures excellent manoeuvrability of the controller.





ANTI-SLIP RUBBER BASE

The superior anti-slip rubber base is as good as glue. It is embossed with the Lorgar logo – gives at least +5 points to your skill. With the total pad thickness of 3mm, you'll be extra comfy.



DOUBLE-STITCHED EDGES

The edge is double-stitched with purple and black thread. Durable, soft, looks amazing.

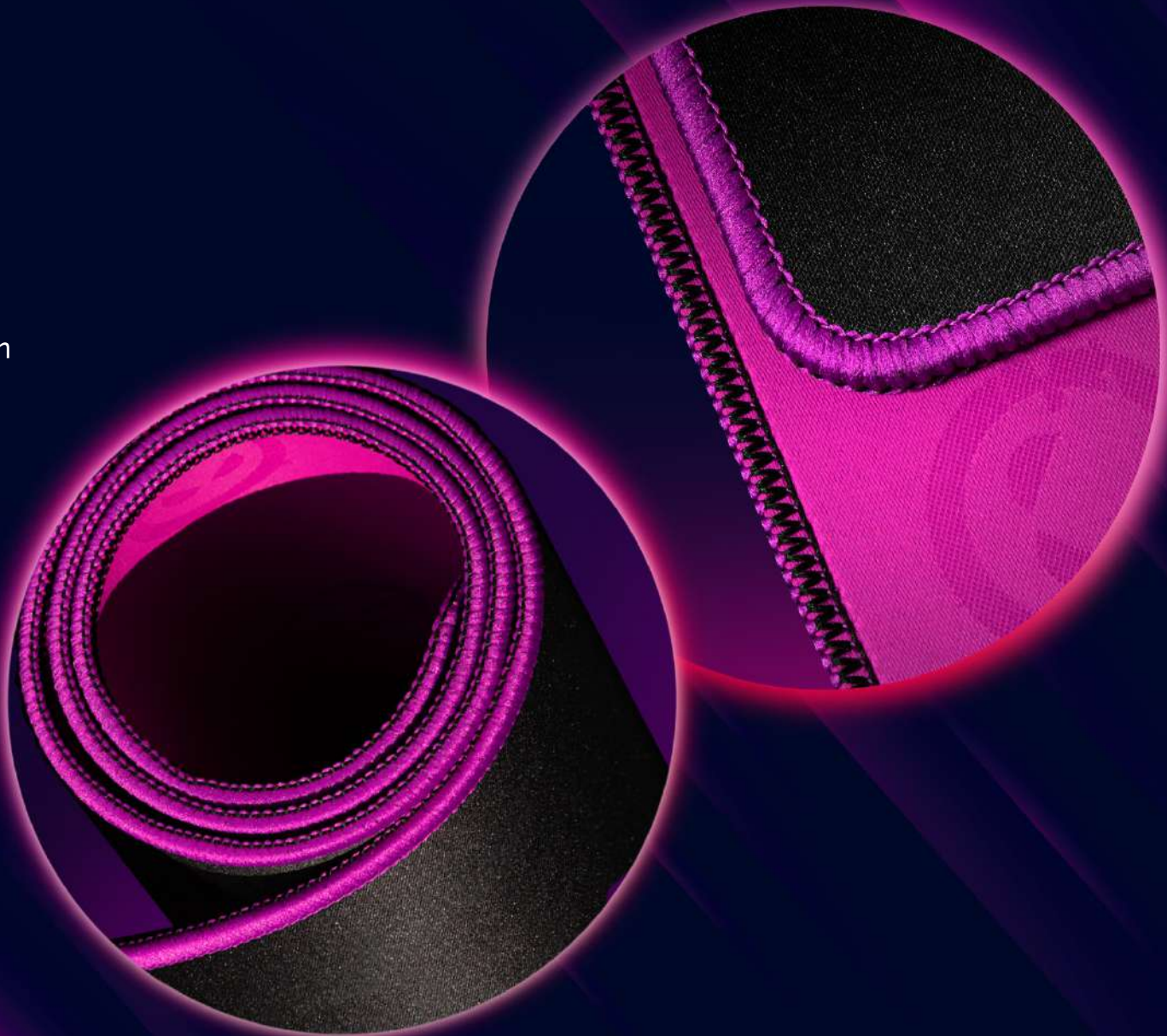

DIFFERENT SIZES

These come in three sizes:

Main 313 – Medium, 360×300mm

Main 315 – Large, 500×420mm

Main 319 – Extra Large, 900×360mm



KEYCHAIN INSIDE

Be sure to retrieve your branded Lorgar keychain before you throw the package away.



TECHNICAL FEATURES

MAIN 313

MAIN 315

MAIN 319

Dimensions	360mm x 300mm x 3mm	500mm x 420mm x 3mm	900mm x 360mm x 3mm
Surface type	High-speed surface with perfect gliding		
Edges	Double-stitched edge for extra durability		
Base	Superior anti-slip rubber base with unique design		
Compatibility	Optimized for all mouse sensitivities and sensors		



MAIN 323 / 325 / 329

Gaming mouse pads



MAIN 323, MAIN 325, MAIN 329 GAMING MOUSE PADS

Here comes the game changer. The Lorgar Main Precision Control series are mousepads that'll make your movement rapid and deadly accurate. The high-resistance surface is made of special thermoplastic fibres with tiny uniform bumps – the mouse will stop dead in its tracks. Thick 3mm foam with a double-stitched edge offers extra durability and comfort. The anti-slip rubber base will help the pad to stay precisely where you put it. No worries about compatibility: every sensor works perfectly with this type of surface.

These pads are available in three sizes: medium, large, and extra large. Get one and show 'em some surgical precision!



Superior positioning



Surface type: control



Anti-slip rubber base (3 mm)



Double stitched edges

● LRG-GMP323	black/red	5291485009861
● LRG-GMP325	black/red	5291485009878
● LRG-GMP329	black/red	5291485009885

PRECISE POSITIONING SURFACE

Ultra-resistant thermoplastic fibres ensure low glide and precise control. High-traction surface offers incomparable accuracy of motion.





ANTI-SLIP RUBBER BASE

The superior anti-slip rubber base is as good as glue. It is embossed with the Lorgar logo – gives at least +5 points to your skill. With the total pad thickness of 3mm, you'll be extra comfy.

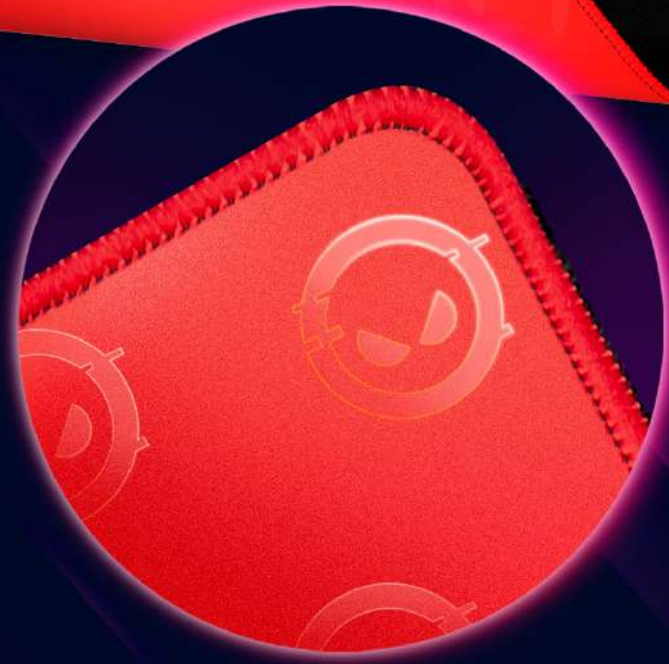

DOUBLE-STITCHED EDGES

The edge is double-stitched with black and red thread to keep your deadly accuracy low profile. Also, it is indeed durable.





DIFFERENT SIZES

These come in three sizes:

Main 323 – Medium, 360×300mm

Main 325 – Large, 500×420mm

Main 329 – Extra Large, 900×360mm

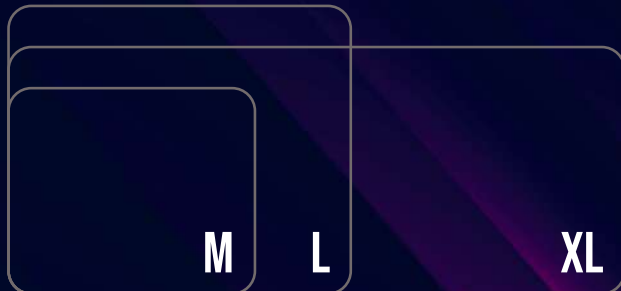

KEYCHAIN INSIDE

Be sure to retrieve your branded Lorgar keychain before you throw the package away.



TECHNICAL FEATURES

MAIN 323

MAIN 325

MAIN 329

Dimensions	360mm x 300mm x 3mm	500mm x 420mm x 3mm	900mm x 360mm x 3mm
Surface type	Precise control surface for accurate positioning		
Edges	Double-stitched edge for extra durability		
Base	Superior anti-slip rubber base with unique design		
Compatibility	Optimized for all mouse sensitivities and sensors		



LEGACER 753/755

Gaming mouse pads



LEGACER 753, LEGACER 755 GAMING MOUSE PADS

Here comes Lorgar Legacer: a mouse pad made to enhance your gaming experience. Legacer series is designed to give you an edge over opponents, with an ultra-smooth glide surface made possible by unique weaving.

You'll feel like your mouse is flying across the surface, making your movements faster and more precise. This nylon material is ready to withstand any abuse, plus there is a water-resistant, easier-to-clean coating. The mouse pad is 3mm thick with a double-stitched edge. The anti-slip rubber base ensures the mouse pad stays in place during intense gaming sessions. You don't need to worry about compatibility either, as every sensor works well with this mouse pad. By the way, we added a Lorgar luminescent logo that glows in the dark. It could help you find your mouse pad once you turn off the lights in your gaming room. The Lorgar Legacer comes packaged in a nice tube, ready to be a gift for a true gamer.

Due to its extreme durability, your grandkids might have a chance to use this mouse pad, too – that's why we called it "Legacer." It is available in two sizes: medium and large. So, choose the one that suits you best and get ready to dominate the competition.



Ultra gliding surface



Water resistant



Anti-slip rubber base



Double stitched edges



● LRG-CMP753	black/purple	5291485009786
● LRG-CMP755	black/purple	5291485009793

OUTSTANDING SURFACE STRUCTURE

A special surface structure ensures ultra-speed. The material has a staggeringly low resistance, thus providing you with the fastest glide possible. The surface is compatible with all types of sensors.





EXTREME DURABILITY

The nylon fibre of special weaving is astonishingly durable – we're talking military-grade durable. You can leave this mouse pad to your grandkids.



LUMINESCENT LOGO

The Lorgar logo glows in the dark — nice touch for playing with your lights off.



CLEANABLE WATER-RESISTANT COATING

There's a water-resistant coating repelling sweat and dirt. This coating also allows for easier cleaning.

DOUBLE-STITCHED EDGES

The edge is double-stitched with white and purple thread. That means increased resistance to wear and tear, keeping your forearm comfy.

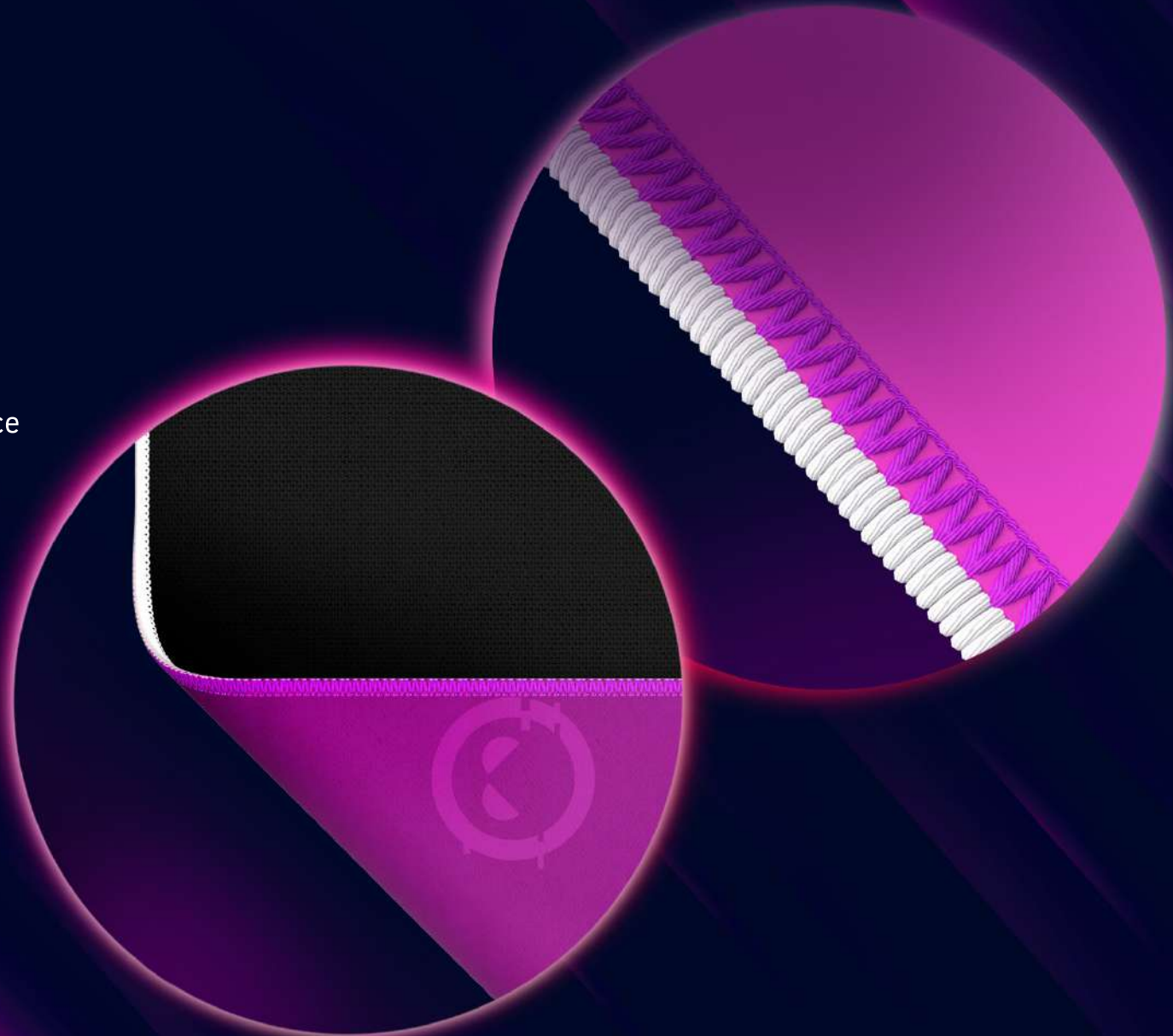

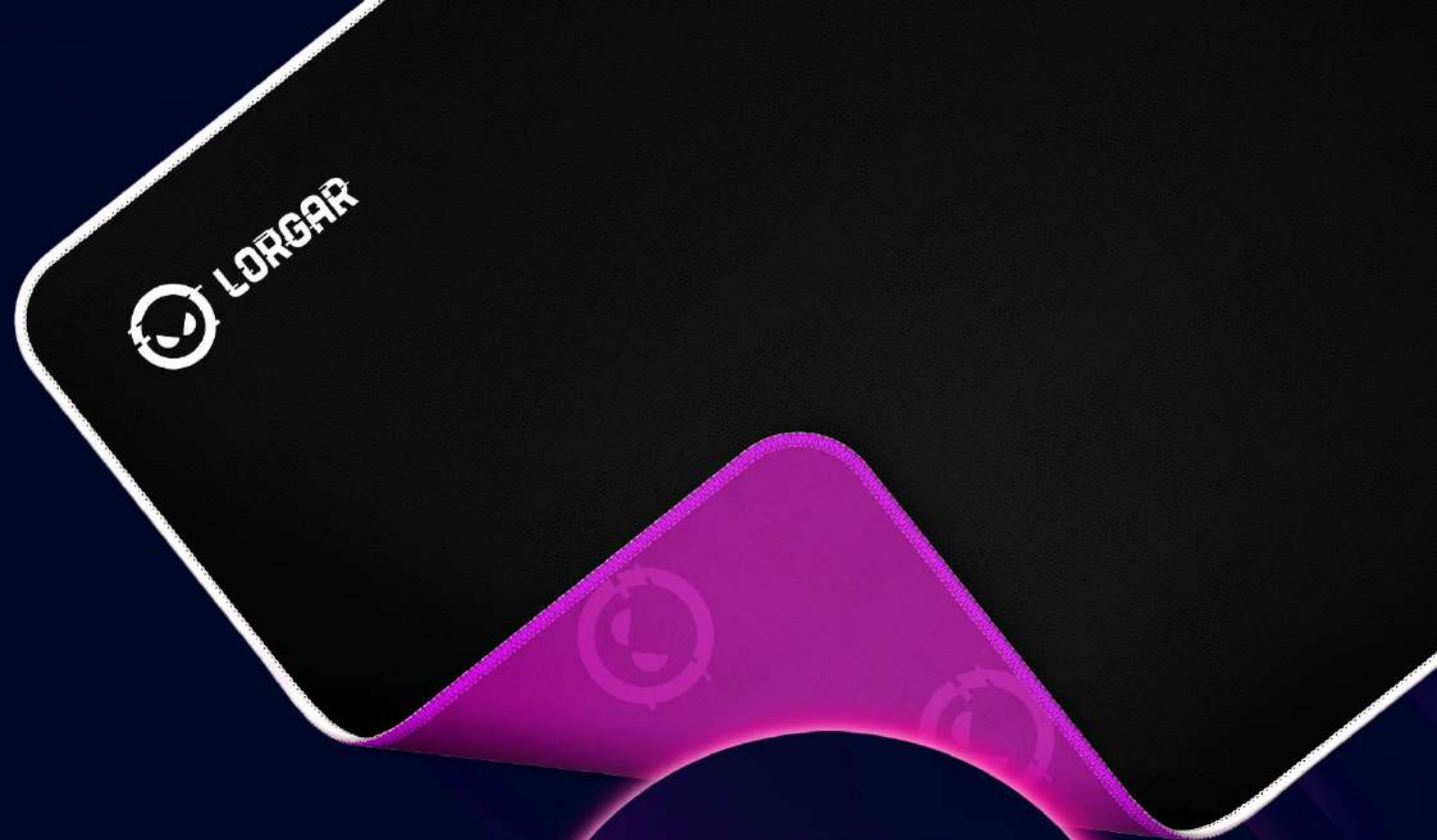

ANTI-SLIP RUBBER BASE

The anti-slip rubber base keeps the mouse pad firmly in place. The base is embossed with the Lorgar logo.



SIZE & PACKAGING

This mouse pad comes in a neat tube – it may serve as a gift box.

Pick one of two sizes:

Legacer 753 – Medium, 360X300 mm

Legacer 755 – Large, 500X420 mm



TECHNICAL FEATURES

LEGACER 753

LEGACER 755

Dimensions	360mm x 300mm x 3mm	500mm x 420mm x 3mm
Surface type	Ultra gliding surface for the fastest movements	
Edges	Double-stitched edge for extra durability	
Base	Superior anti-slip rubber base with unique design	
Compatibility	Optimized for all mouse sensitivities and sensors	



STELLER 913/919

Gaming mouse pads



STELLER 913, STELLER 919 GAMING MOUSE PADS

The Lorgar Steller mouse pads will revolutionize your gaming setup. The super glide surface with low-resistance fibers makes your moves fast and agile. Have no worries about compatibility – the Steller’s surface is friendly to every sensor type. No matter how active your movement is, the anti-slip rubber base keeps your mouse pad steady.

The mouse pad has an advanced RGB backlight, but words aren’t enough: you need to see it in action. Connect the Steller mouse pad to your gaming rig via USB and customize it with Lorgar Platform. While you’re at it, sync it with compatible Lorgar devices, such as your Lorgar mouse. Now, what you’re getting is a mesmerizing and synchronized lighting experience that looks jaw-dropping.

Available in medium and extra-large sizes. Choose the one and dominate the game!



5 modes
of RGB backlight



Surface type:
speed



Anti-slip
rubber base (3 mm)



- LRG-GMP913 | black | 5291485010225
- LRG-GMP919 | black | 5291485010232



SUPERIOR GLIDE SURFACE

Engineered by industry experts, our mouse pads boast smooth, low-resistance fibers that enhance your mouse's speed to lightning-fast levels. The super glide surface further guarantees exceptional controller maneuverability.





ANTI-SLIP RUBBER BASE

The superior anti-slip rubber base is as good as glue. With the total pad thickness of 3mm, you'll be extra comfy.



RGB BACKLIGHT

Elevate your gaming setup with the advanced RGB backlight in your mouse pad. Connect it via USB and enjoy a fresh visual experience.



CUSTOMIZATION WITH LORGAR PLATFORM

The experience is fully customizable, thanks to our Lorgar Platform. Select your preferred brightness and colour. Choose between 5 backlight modes: Static, Spectrum, Breathing, Heartbeat, and Stream. Monitor your gaming performance and statistics – see how much time with your new Steller mouse pad has been spent in-game.





BACKLIGHT SYNCHRONIZATION

Immerse yourself in the harmony of light. Use Lorgar Platform to sync the backlight with your Lorgar mouse or any compatible Lorgar device.



DIFFERENT SIZES

The Steller mouse pads come in two sizes:

Steller 913 – Medium, 360×300mm

Steller 919 – Extra Large, 900×360mm

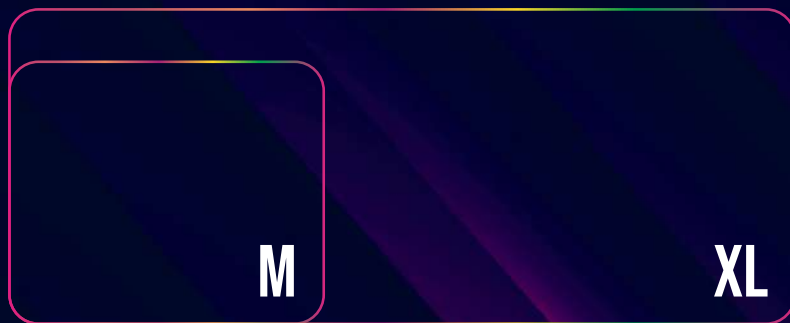



KEYCHAIN INSIDE

Be sure to retrieve your branded Lorgar keychain before you throw the package away.



TECHNICAL FEATURES



STELLER 913

STELLER 919

Dimensions	360mm x 300mm x 3mm	900mm x 360mm x 3mm
Surface type	High-speed surface with perfect gliding	
Backlight	5 modes of RGB backlight	
Software	Lorgar Platform	
Base	Superior anti-slip rubber base	
Compatibility	Optimized for all mouse sensitivities and sensors	

GAMING MOUSE PAD PORTFOLIO



MAIN 133/135/139



MAIN 313/315/319



MAIN 323/325/329



LEGACER 753/755



STELLER 913/919

Dimensions	360mm x 300mm 500mm x 420mm 900mm x 360mm	360mm x 300mm 500mm x 420mm 900mm x 360mm	360mm x 300mm 500mm x 420mm 900mm x 360mm	360mm x 300mm 500mm x 420mm	360mm x 300mm 900mm x 360mm
Surface type	High-speed	High-speed	Precise control	Ultra-gliding	High-speed
RGB backlight	No	No	No	No	Yes
Software support	No	No	No	No	Yes
Base	Superior anti-slip rubber base, 3mm thickness				
Compatibility	Optimized for all mouse sensitivities and sensors				

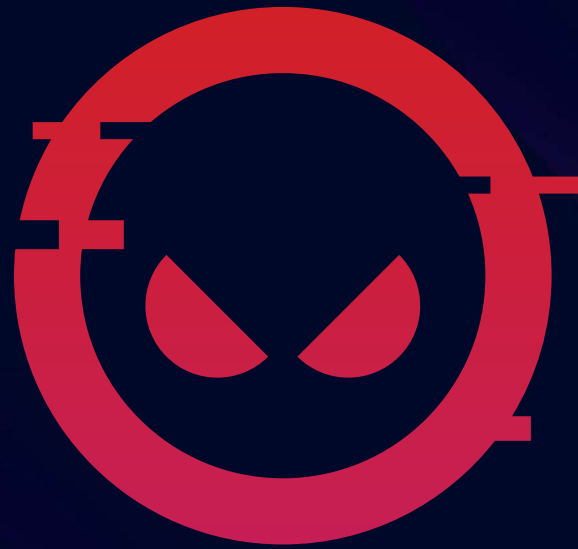

READY TO PLAY